

Exterior Material Finishes Catalog Cut Sheets

Hartwell Heights Perinton, New York

Product List:

- LP Smartside - Clapboard Siding
- IKO Dynasty Shingle Roofing
- Azek Trim Products
- Andersen 100 Series Windows & Sliding Doors
- Clopay Bridgeport - Garage Doors
- Therma-Tru Smooth Star - Entry & French Doors
- Mid-America - Louvered Shutters
- RDI Avalon - Aluminum Railings
- 929 - Exterior Wall Lantern Lighting
- Timber Tech - Terrain Collection Decking
- Streetworks - Street Pole Lights



- Product Items Specified



COLORFUL SIDING. BEAUTIFUL FINISH.

LP® SMARTSIDE® EXPERTFINISH® TRIM & SIDING

The advanced durability you expect from LP® SmartSide® Trim & Siding comes in ExpertFinish® colors. Your homeowners will love choosing colors to match their style—and you'll love the fast and easy installation that comes with LP SmartSide ExpertFinish Trim and Siding.

- ExpertFinish Lap Joint Siding to avoid the need for most seam caulking, joint molds, or pan flashing
- Now available in brushed smooth and cedar texture
- Advanced Durability for Longer Lasting Beauty®
- Available in 16 versatile colors that will complement most any home's style
- Industry-leading 5/15/50 year prorated limited warranty: 5-year labor and materials, 15-year finish, and 50-year substrate
- Comes in a variety of SKUs and finishes

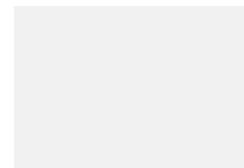

Snowscape White

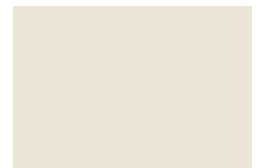

Sand Dunes



Desert Stone



Quarry Gray



Prairie Clay



Terra Brown



Harvest Honey



Timberland Suede



Garden Sage



Redwood Red



Tundra Gray



Summit Blue



Rapids Blue



Cavern Steel



Midnight Shadow

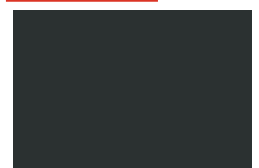

Abyss Black



For complete product & warranty details, visit LPCorp.com/ExpertFinish

Products Available in LP SmartSide ExpertFinish Colors

Lap Joint Siding

•38 Series 6" x 16' – 5.84 in. (148 mm) x 192 in. (4.9 m)

•38 Series 8" x 16' – 7.84 in. (199 mm) x 192 in. (4.9 m)

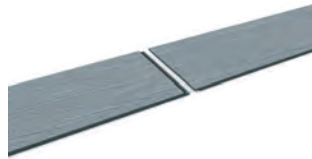

Trim

•540 Series 5" x 16' – 194 in. (4.9 m) x 192 in. (4.9 m)
*Quebec only**

•440/540 Series 4" x 16' – 3.50 in. (89 mm) x 192 in. (4.9 m)

•440/540 Series 6" x 16' – 5.50 in. (140 mm) x 192 in. (4.9 m)

•440/540 Series 8" x 16' – 7.21 in. (183 mm) x 192 in. (4.9 m)

•440/540 Series 10" x 16' – 9.21 in. (234 mm) x 192 in. (4.9 m)

•440/540 Series 12" x 16' – 11.21 in. (285 mm) x 192 in. (4.9 m)

•190 Series 3" x 16' – 2.5 in. (64 mm) x 192 in. (4.9 m)

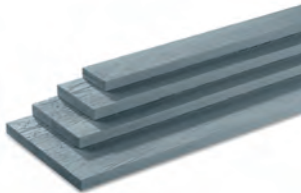

Shakes

•38 Series 12" x 48" – 11.624 in. (295 mm) x 48.63 in. (1.2 m)

•Reversible staggered or straight edge



Panel

•38 Series 4' x 8' – 48.56 in. (1234 mm) x 96 in. (2.4 m)

•38 Series 4' x 10' – 48.56 in. (1234 mm) x 120 in. (3 m)*



We're not just building for the future, we're promoting forest regeneration and preserving wildlife habitats for the benefit of all generations to come.

All photos are for illustrative purposes only. Please refer regularly to LPCorp.com for correct and up-to-date product installation instructions.

WARNING: Drilling, sawing, sanding or machining wood products can expose you to wood dust, a substance known to the State of California to cause cancer. Avoid inhaling wood dust or use a dust mask or other safeguards for personal protection. For more information go to www.P65Warnings.ca.gov/wood.



Nickel Gap

•Nickel Gap 8" x 16' – 7 in. (177 mm) x 192 in. (4.9 m)



Vertical Siding

•38 Series 16" x 16' – 15.94 in. (405 mm) x 192 in. (4.9 m)



Soffit

•38 Series 12" Closed/Vented Soffit – 11.94 in. (303 mm) x 192 in. (4.9 m)

•38 Series 16" Closed/Vented Soffit – 15.93 in. (405 mm) x 192 in. (4.9 m)

•38 Series 24" Closed/Vented Soffit – 23.94 in. (608 mm) x 192 in. (4.9 m)

•Vented Soffit Only Available in Cedar

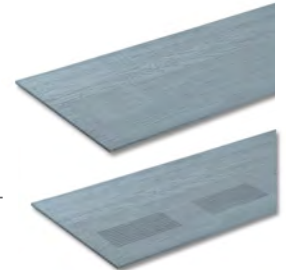

Outside Corners

•540 Series 4" x 10' – 3.625 in. (89 mm) x 120 in. (3.0 m)*

•540 Series 6" x 10' – 5.625 in. (140 mm) x 120 in. (3.0 m)*



J-Blocks

•540 Series 7.25" x 7.25" – 7.21 in. (183 mm) x 7.21 in. (183 mm)

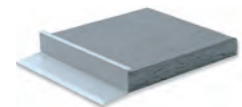

Mini Splits

•540 Series 7.25" x 6.75" – 7.21 in. (183 mm) x 6.75 in. (171 mm)

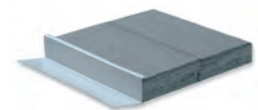

* Only Available in Cedar Texture
Not all products available in all colors



For complete product & warranty details, visit LPCorp.com/ExpertFinish



DYNASTY®

Performance Shingles



High-Performing Laminated Shingles for the Weather-Conscious Homeowner.



IKO
ARMOURZONE®



HIGH-WIND
RESISTANCE



ENHANCED
COLORS



IR
CLASS 3
CLASS 3 IMPACT
RESISTANCE RATING³

When your customers want a roof that's a step above the rest, Dynasty Performance shingles provide an upgraded experience in multiple ways. Dynasty shingles feature our ArmourZone® 1 1/4-inch reinforced nailing surface, offering roofers a wider margin compared to standard architectural shingles. This tear-resistant band also makes Dynasty shingles less susceptible to wind uplift and includes a high-wind warranty for coverage up to 130 mph.

Plus, Dynasty shingles feature enhanced colors and a Class 3 impact resistance rating for upgraded defense against hail^{3*}.

The IKO Difference

With a legacy of craftsmanship that spans over 75 years, we know quality. That's why contractors and their customers trust IKO to deliver beautiful, high-performing roofing systems that can withstand rigorous conditions — and continue protecting families for generations to come.

*This is not a guarantee of impact resistance against hail. Damage from hail is not covered under the limited warranty. See full details³.

Wind resistance and fast installation — nailed.

IKO's Dynasty line stands a cut above the industry for shingles that perform from installation to weathering homeowners' toughest storms. These laminated performance shingles offer:

- **ArmourZone** 1 1/4-inch reinforced nailing surface for unparalleled holding power.
- **Class 3** impact resistance rating³.
- A wide range of **enhanced** color blends.
- **True Square Advantage** sizing providing exactly 100 square feet of coverage in every three bundles, helping minimize waste and installation costs.
- Resistance against **blue-green algae** streaks and discoloration.
- **FastLock**® sealant, activated by the warmth of the sun to seal down and help protect against wind uplift.



DYNASTY®

Performance Shingles



SPECIFICATIONS ⁴	Limited Warranty ¹	Limited Lifetime ²	Dimensions (L x W)	40 7/8 in (1,038 mm) X 13 3/4 in (349 mm)	STANDARDS ⁵	ASTM D3462
	Iron Clad Protection ¹	15 Years	Exposure	5 7/8 in (149 mm)		ASTM D3018
	Limited Wind Warranty ¹	130 mph	Coverage per Bundle	33 1/3 sq. ft. (3.1 sq. m)		ASTM D7158 — Class H
	Limited Algae Resistance Warranty ¹	10 years (blue-green)	Shingles per Square	60		ASTM D3161 — Class F ASTM E108/UL 790 — Class A FM 4473 — Class 3 ³



Note: Product and color availability may vary by region. Products with Miami Dade NOA and FBC product approval listings are available. Meets Texas Department of Insurance requirements. Contact IKO for details. ¹Refer to the Limited Warranty at IKO.com for full terms, conditions, restrictions and application requirements. Shingles must be installed per application instructions and local building codes. ²"Lifetime" refers to the period from installation until the original Owner no longer owns the building. ³Impact rating is solely for potential insurance premium reductions and is not a performance guarantee, implied or express warranty of any kind. Hail damage is not covered under the Limited Warranty. IKO recommends Class 4 or 3 impact resistance rated Hip and Ridge capping shingles be installed with corresponding impact rated shingles (refer to FM Approvals for more details on the FM 4473 impact resistance testing standard). ⁴All values are approximate. ⁵Products are developed with reference to these standards. ⁶Blue granules may tend to fade with prolonged UV exposure. ⁷Matte Black roofs may show shading (lighter or darker in some locations), which is not considered a defect under the terms of our warranty.

IMPORTANT! For complete satisfaction, view full-size shingles and an actual roof installation before selecting a color. Online swatches, brochures, and our **ROOFViewer**® tool may not accurately reflect the shingle color or full color blend range, nor show the impact of sunlight.

Information is subject to change without notice. We assume no responsibility for errors or omissions in this literature.



Find out more about our products now by talking to an IKO sales representative or contact us directly:
1-888-IKO-ROOF (1-888-456-7663).
Or visit our website at: **IKO.COM.**



▶ SEE IT ON A ROOF

▶ IKO.COM/NA

Become an **IKO ROOFPRO** Member.
Call 1-866-ROOFPRO or visit us online ikoroofproconnect.com

SIDING | TRIM | ACCESSORIES

Engineered to last beautifully



#1
in premium
trim

TRIM, SPECIALTY PROFILES & MOULDING

Beautiful, efficient & long-lasting trim

Trim beautifies a home, but its first job is protecting against water damage. AZEK® offers more trim sizes and solution-based moulding profiles than any other brand on the market. Using the insight of contractors, architects, and homeowners, we have been solving exterior problems for over 25 years.

AZEK
Classic Trim

AZEK Flange
Slotted Trim

One-Piece
Column Wrap



Details make the difference

AZEK® Trim

Quality AZEK Trim protects against moisture infiltration and adds the final touch that takes an exterior from good to great. It comes in the sizes and dimensions pros want, with choices of smooth and woodgrain finish in Classic White or reversible smooth/woodgrain with PaintPro® Technology.

12'	16'	18'	20'
-----	-----	-----	-----

5/8 X Thickness

Nominal	Actual				
5/8 x 5 1/2	5/8" x 5 1/2"	S	W	S	W
5/8 x 5 1/2	5/8" x 5 1/2"	S	W	S	W
5/8 x 7 1/4	5/8" x 7 1/4"	S	W	S	W
5/8 x 9 1/4	5/8" x 9 1/4"	S	W	S	W
5/8 x 11 1/4	5/8" x 11 1/4"	S	W	S	W
5/8 x 15 1/4	5/8" x 15 1/4"	S	W	S	W

4/4 X Thickness

Nominal	Actual				
1 x 2	3/4" x 1 1/2"		P	S	W
1 x 3	3/4" x 2 1/2"		P		
1 x 4	3/4" x 3 1/2"	S	W	P	S
1 x 5	3/4" x 4 1/2"	S	W		S
1 x 6	3/4" x 5 1/2"	S	W	P	S
1 x 8	3/4" x 7 1/4"	S	W	P	S
1 x 10	3/4" x 9 1/4"	S	W	P	S
1 x 12	3/4" x 11 1/4"	S	W	P	S
1 x 16	3/4" x 15 1/4"	S	W	P	S

5/4 X Thickness

Nominal	Actual				
5/4 x 4	1" x 3 1/2"	S	W	P	S
5/4 x 5	1" x 4 1/2"	S	W		S
5/4 x 6	1" x 5 1/2"	S	W	P	S
5/4 x 8	1" x 7 1/2"	S	W	P	S
5/4 x 10	1" x 9 1/2"	S	W	P	S
5/4 x 12	1" x 11 1/2"	S	W	P	S
5/4 x 16	1" x 15 1/2"	S	W	P	S

12'	16'	18'	20'
-----	-----	-----	-----

6/4 X Thickness

Nominal	Actual				
6/4 x 4	1 1/2" x 3 1/2"				W
6/4 x 6	1 1/2" x 5 1/2"				W
6/4 x 8	1 1/2" x 7 1/4"				W
6/4 x 10	1 1/2" x 9 1/4"				W
6/4 x 12	1 1/2" x 11 1/4"				W

8/4 X Thickness

Nominal	Actual				
8/4 x 2	1 1/2" x 1 1/2"		P	S	
8/4 x 4	1 1/2" x 3 1/2"		P	S	
8/4 x 6	1 1/2" x 5 1/2"		P	S	
8/4 x 8	1 1/2" x 7 1/4"		P	S	
8/4 x 10	1 1/2" x 9 1/4"		P	S	
8/4 x 12	1 1/2" x 11 1/4"		P	S	

*AZEK Trim, including 8/4 boards, is not suitable for structural use.

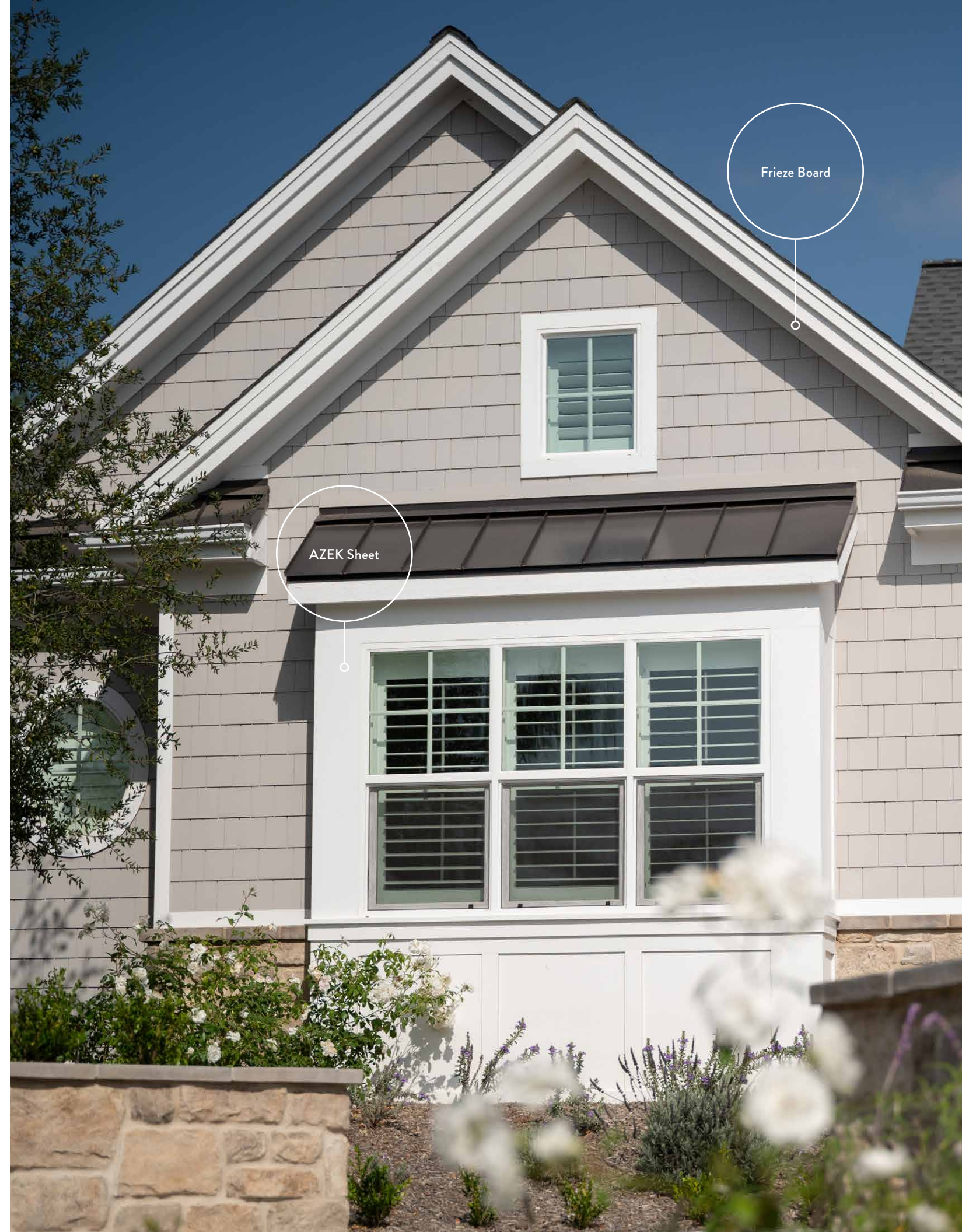

See trim engineered specifically for AZEK Lap Siding on page 24.



AZEK® Sheet

Applications over 16" wide are easy with AZEK Sheet. Use Sheet for bay windows, dormers, and raised panels.

	8'	10'	12'	18'	20'
Actual					
3/8" x 4'	S W	S W	S	S	
1/2" x 4'	S W P	S W P	S P	S	
5/8" x 4'	S	S	S	S	
3/4" x 4'	S W P	S W P	S	S	
1" x 4'	S	S	S	S	S

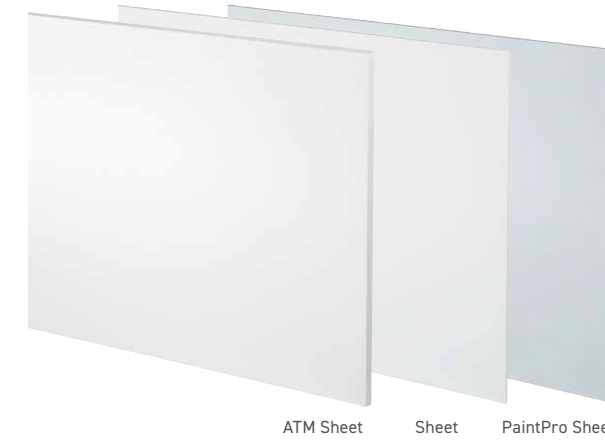

AZEK-to-Mill

ATM's thick profile makes it ideal for fabrication. Its consistent density offers a superior product for milling operations.

	8'	10'	12'	18'	20'
Actual					
1 1/2" x 9 1/2"				S	
1 1/2" x 3 1/2"				S	
1 1/2" x 5 1/2"				S	
1 1/2" x 7 1/2"				S	
1 1/2" x 9 1/2"				S	
1 1/2" x 11 1/2"				S	
1 1/2" x 48" Sheet	S				
1 1/2" x 48" Sheet*	S	S	S		S

*16' length available in PaintPro®.

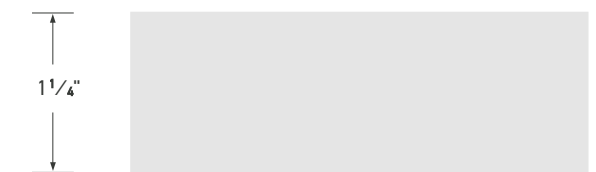

Product Finish Availability Smooth **S** Woodgrain **W** PaintPro **P**

Flange Slotted Window & Rabbeted Trim

By removing the challenges of complex cuts and caulking, Flange Slotted Window Trim and Rabbeted Trim create beautiful, consistent, and long-lasting window surrounds. Ideal for replacing existing trim or in new construction, the trim has a 1-1/8" to 1-1/2" pocket, hiding siding ends or window nailing fins.

18'

Flange Slotted Window Trim

Nominal	Actual	
5/4 x 4 Slotted*	1" x 3 1/2"	S W
5/4 x 6 Slotted*	1" x 5 1/2"	S W

*Available in Classic White or PaintPro®.

Rabbeted Trim

Nominal	Actual	
5/4 x 4	1" x 3 1/2" with 1-1/8" Rabbeted Channel	S W P
5/4 x 6	1" x 5 1/2" with 1-1/2" Rabbeted Channel	S W P
5/4 x 8	1" x 7 1/2" with 1-1/2" Rabbeted Channel	S W P

Flange Slotted & Rabbeted Trim

Nominal	Actual	
5/4 x 4 Slotted & Rabbeted	1" x 3 1/2" with 1-1/8" Rabbeted Channel	S W
5/4 x 6 Slotted & Rabbeted	1" x 5 1/2" with 1-1/2" Rabbeted Channel	S W



Product Finish Availability Smooth S Woodgrain W PaintPro P



Cornerboards

AZEK® Cornerboards offer faster installations and a seamless finish to complement any home exterior. Unlike two-piece cornerboards, which attract dirt in the seam, our one-piece cornerboards feature smooth outside edges to keep dirt away during installation.

10' 20'

Cornerboard

Nominal	Actual		
5/4 x 4 x 4	1" x 3 1/2" x 3 1/2"	<input checked="" type="checkbox"/> S <input checked="" type="checkbox"/> W <input checked="" type="checkbox"/> P	<input checked="" type="checkbox"/> S <input checked="" type="checkbox"/> W <input checked="" type="checkbox"/> P
5/4 x 6 x 6	1" x 5 1/2" x 5 1/2"	<input checked="" type="checkbox"/> S <input checked="" type="checkbox"/> W <input checked="" type="checkbox"/> P	<input checked="" type="checkbox"/> S <input checked="" type="checkbox"/> W <input checked="" type="checkbox"/> P
5/4 x 8 x 8*	1" x 7 1/2" x 7 1/2"		<input checked="" type="checkbox"/> S

Rabbeted Cornerboard

Nominal	Actual		
5/4 x 4 x 4	1" x 3 1/2" x 3 1/2"	<input checked="" type="checkbox"/> S <input checked="" type="checkbox"/> W	<input checked="" type="checkbox"/> S <input checked="" type="checkbox"/> W <input checked="" type="checkbox"/> P
5/4 x 6 x 6	1" x 5 1/2" x 5 1/2"	<input checked="" type="checkbox"/> S <input checked="" type="checkbox"/> W	<input checked="" type="checkbox"/> S <input checked="" type="checkbox"/> W <input checked="" type="checkbox"/> P
5/4 x 8 x 8*	1" x 7 1/2" x 7 1/2"		<input checked="" type="checkbox"/> S

Inside Cornerboard

Nominal	Actual		
2 x 2	1 1/2" x 1 1/2"		<input checked="" type="checkbox"/> P

*5/4 x 8" x 8" only available in Traditional

GET A QUICK, SEAMLESS & CLEAN INSTALLATION



✗ THE PROBLEM

Multiple pieces require more time and labor. Caulk is required to combine two trim boards. Other materials are not approved for ground and masonry contact.

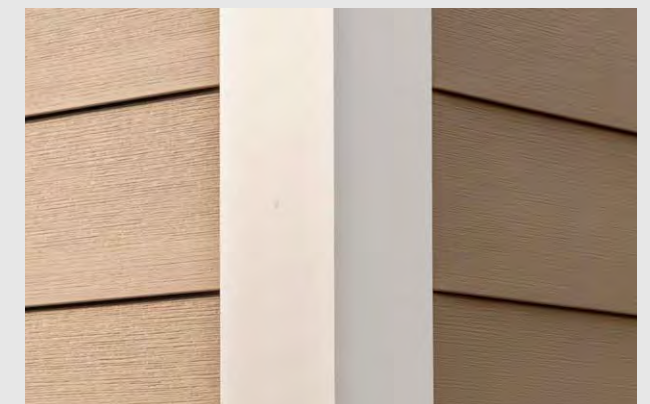

✓ THE SOLUTION

AZEK Cornerboard means no seams, no caulk, and no paint required. Lengths up to 20' make installation faster.

Skirt Boards

The perfect transition between grade and siding, our matte white skirt boards are approved for ground contact without worry or the need for additional flashing or starter strips. The one-piece version (also available with PaintPro®) in either smooth or woodgrain has an integral flange and angled top to help manage water. The universal version is smooth/woodgrain reversible and features a separate metal water management flange that fits into a routed groove.

16' 18'

One-Piece Skirt Board

Nominal	Actual			
4/4 x 8	3/4" x 7 1/2"			S W
4/4 x 10	3/4" x 9 1/2"			S W
5/4 x 8 x 8*	1" x 7 1/2" x 7 1/2"			S W
5/4 x 6	1" x 5 1/2"			S W
5/4 x 8	1" x 7 1/2"			S W
5/4 x 10	1" x 9 1/2"	P		S W

Universal Skirt Board

Nominal	Actual			
5/4 x 6	1" x 5 1/2"			W
5/4 x 8	1" x 7 1/2"			W
5/4 x 10	1" x 9 1/2"			W
5/4 x 12	1" x 11 1/2"			W

1 1/2" nailing flange length & 1/4" drip edge overhang

Integrated Drip Edge

AZEK® Integrated Drip Edge channels water away from window and door surrounds. The two-piece system includes a metal drip edge that fits into a groove routed in the trim board. The board itself is smooth/woodgrain reversible.

18'

Nominal	Actual	
5/4 x 4	1" x 3 1/2"	W
5/4 x 6	1" x 5 1/2"	W

1 1/2" nailing flange length & 1/8" drip edge overhang

SAVE ON INSTALLATION TIME & COST



✗ THE PROBLEM

Wood trim has failing paint, messy caulk, and is not approved for ground or masonry contact.



✔ THE SOLUTION

AZEK One-Piece Skirt Board is moisture resistant and approved for ground contact.



One-Piece Skirt Board



Integrated Drip Edge



Universal Skirt Board



Beadboard (E & CB)

Edge and Center Bead comes as boards in two widths with a regular tongue-and-groove profile or as 4' x 8' sheets for covering large areas quickly. Once installed, the look is identical. Because they are face-nailed, they have excellent wind performance with UL 580 90 mph certification. Retains its crisp, white appearance with minimal upkeep.

Actual	18'
1/2" x 3 1/2"	<input checked="" type="radio"/>
3/4" x 3 1/2"	<input checked="" type="radio"/>
3/4" x 5 1/2"	<input checked="" type="radio"/>

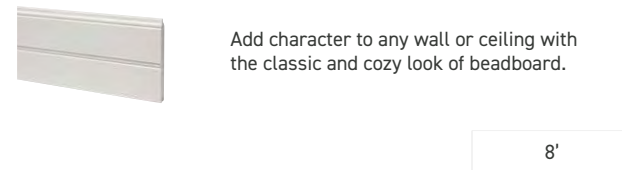

Actual	8'
1/2" x 4'	<input checked="" type="radio"/>

Traditional Beadboard

The two key advantages to AZEK Traditional Beadboard are a nailing flange for hidden fastening and a reversible profile with one side dual-beaded and the other side smooth with V-groove edges. AZEK PVC makes these rot-proof boards moisture and insect resistant, plus they're flexible for curved applications.

Actual	18'
5/8" x 3 1/2"	<input checked="" type="radio"/>
1/2" x 5 1/2"	<input checked="" type="radio"/>



*Features a nailing flange for easier installation.

Product Finish Availability Smooth Woodgrain PaintPro

Shiplap & Nickel Gap

Bring the contemporary look of wider planks with shiplap or nickel gap. Both deliver similar finished looks, but the nickel gap and reversible WP4 allow for hidden fasteners. Each profile type is suitable for horizontal or vertical orientation.

Actual	18'
3/4" x 5 1/2"	<input checked="" type="radio"/>
3/4" x 7 1/2"	<input checked="" type="radio"/>

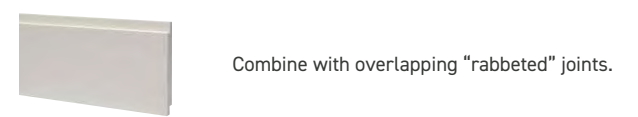

Actual	8'
3/4" x 5 1/2"	<input checked="" type="radio"/>
3/4" x 7 1/2"	<input checked="" type="radio"/>

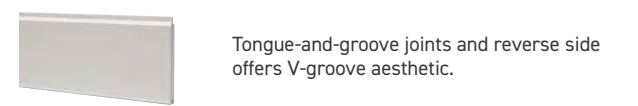

ENDLESS CEILING DESIGNS WITH THREE INSTALL OPTIONS

Elevate spaces with a perfect blend of timeless style and cutting-edge durability. Beadboards and Beaded Sheets offer beautiful coverage for ceilings under decks, porches, or gazebos. Like all AZEK® Trim and Moulding, beaded profiles are made from moisture-resistant, low-maintenance PVC and designed to complement exteriors. No paint needed, but may be painted per AZEK guidelines.

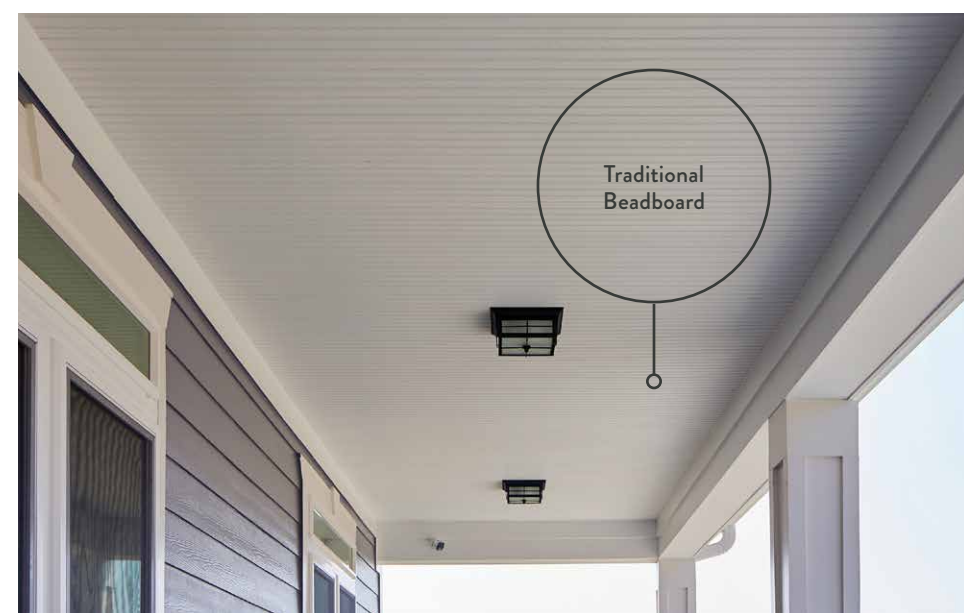

Outdoor-ready, finished wood look

AZEK® Alpine Collection

AZEK® Alpine handles humidity and moisture effortlessly and is a perfect solution for ceilings, soffits, porches, gazebos, and more. Combining low-maintenance polymer materials with a final layer of realistic, warm woodgrain finishes, Alpine Collection WP4 and Beadboard profiles add a high-end, polished detail to exterior locations with the appearance of premium stained lumber.



Crown and Bed Moulding

Finish off projects with Alpine Crown Moulding and Bed Mould, available in 16' lengths in all six colors.

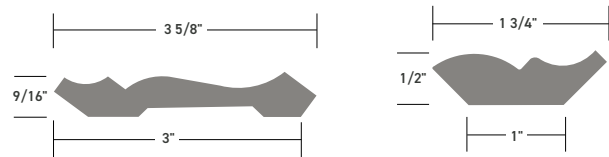

WP4

WP4 delivers the modern, wide-plank look to your project. The WP4 profile enables hidden fasteners. Available in 18' lengths.

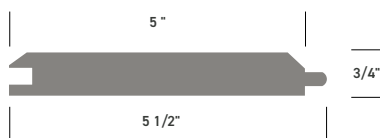

Trim Boards

Versatile Alpine Trim boards, available in 1" x 8" and 1" x 12" sizes, are laminated on 3+ sides in the six Alpine colors to match perfectly and minimize touch-ups.



Beadboard

AZEK Alpine Beadboard provides a traditional, rustic farmhouse look with center bead. Consistent interlocking design means tight joints and easy installation. Available in 18' lengths.

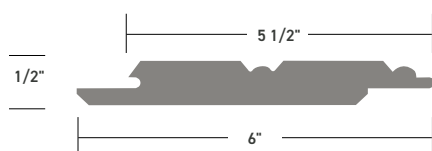

AZEK Alpine Beadboard in Mission Oak

EXPLORE AZEK ALPINE COLLECTION

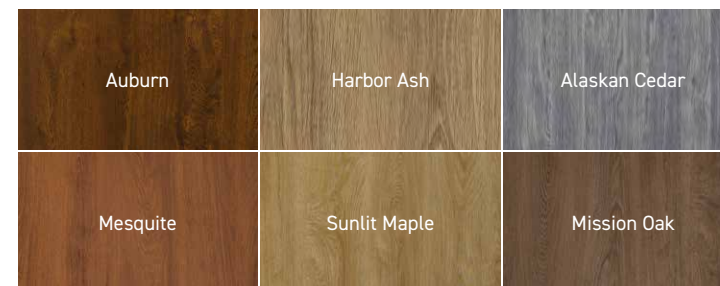

COLOR-MATCH DAUBER

Cover exposed end cuts with an exact match for any of the six Alpine colors. Easy to use and re-use, it also conceals surface dings perfectly.





One-Piece Column Wrap

This easy-to-install column wrap is made from a single piece of PVC and quickly dresses up a structural wood post. Glue the snap-fit seams, attach to the post, and trim to finish the architectural look.

Nominal	Inside Dimension	Outside Dimension	8' 6"		10'	
			Available	Available	Available	Available
4 x 4	3 1/2" x 3 3/4"	4 3/4" x 4 3/4"	S	S	S	S
6 x 6	5 1/2" x 5 3/4"	6 3/4" x 6 3/4"	S	S	S	S
8 x 8	8 1/2" x 8 1/2"	9 1/2" x 9 1/2"	S	S	S	S



Installs quickly with four precut interlocking boards.

Tapered Column

AZEK® Tapered Column combines a craftsman aesthetic with a column wrap's ease of installation. Four precut panels feature a friction-fit miter lock joint for a secure fit and correct panel angle. Includes squaring corners and 3 1/2" decorative skirt pieces for the cap and base.

Actual	5'		6'	
	Available	Available	Available	Available
12" base / 8" cap	S	S	S	S
16" base / 12" cap	S	S	S	S

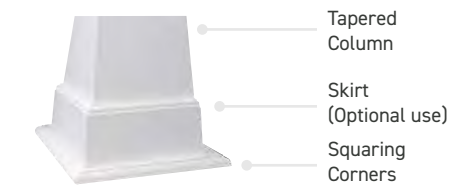

One-Piece Column Wrap Accessories

Take your column wraps from simple to sophisticated with durable PVC moulding kits, accent wraps, and more accessories.

Description	4"	6"	8"
TRIM KIT - BASE MLDG	S	S	S
TRIM KIT - BED MLDG	S	S	S
TRIM KIT - BED MLDG XL	S	S	S
TRIM KIT - CROWN MLDG	S	S	S
TRIM KIT - CROWN MLDG XL	S	S	S
ACCENT WRAP 10"	S	S	S



Kits connect with precut dovetails to speed installation on decorative details.



Product Finish Availability Smooth **S** Woodgrain **W** PaintPro **P**

J-Casing

AZEK® J-Casing offers a beautiful and seamless transition between siding and trim. Engineered to reduce labor and save costs by eliminating the need for field-applied paint and caulk.

	12'	16'	18'
--	-----	-----	-----

J-Casing

Description	Actual			
1 x 4 J-Casing	1 1/8" x 3 1/2"		S	S
1 x 6 J-Casing	1 1/8" x 5 1/2"		S	

Brick Mould J-Casing

Description	Actual			
Brick Mould J-Casing	1 1/2" x 2"			S

GET FASTER INSTALLATIONS WITH NO PAINT OR CAULK



✗ THE PROBLEM

Requires separate purchase and use of trimboard and J-Channel.

✓ THE SOLUTION

AZEK® J-Casing has an integrated J-Channel and doesn't require paint for protection, reducing installation time and cost.



J-Channel Quick-Corner®

Quick Corner uses hidden fasteners so there's no face nailing or paint touch-up. Plus, its 3/4" channel works with multiple siding types.

20'

J-Channel Quick-Corner® Outside Corner

Description	Actual		
4 x 4 J-Quick Corner	1" x 3 1/2" x 3 1/2"		S
6 x 6 J-Quick Corner	1" x 5 1/2" x 5 1/2"		S

J-Channel Quick -Corner® Inside Corner

Description	Actual	
3 x 3 J-Quick Corner	3/4" x 2 1/2" x 2 1/2"	S

TRIM OUT CORNERS QUICKLY, CLEANLY & SEAMLESSLY

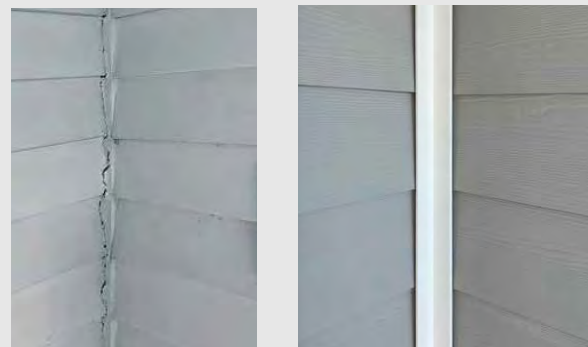

✗ THE PROBLEM

Caulked inside corners look messy and often are not watertight.

✓ THE SOLUTION

J-Channel Inside Corner gives a clean, finished look, attaches with hidden fasteners, and works with most siding systems.





Solid & Vented Soffit

Available in both solid and vented, AZEK® Soffit provides beautiful, durable finishing and vital ventilation for any home exterior. Designed with 10" of free air space per lineal foot to meet most building codes, its vents are cut at an angle to prevent insects from nesting without additional screening.

	Vented 18'	Solid 18'
Actual		
½" x 12"	S	S
½" x 16"	S	S

Frieze & Fascia

Use the frieze board and notched fascia for an efficient, easy-to-install soffit system. Both have a 1/2"-deep groove to smoothly join with soffits. The notched fascia requires no flashing or cover.

20'

Notched Fascia

Description	Actual
4/4 x 8	½" x 7 ½" S



Frieze Board

Description	Actual
5/4 x 6	1" x 5 ½" S



Cortex® Fastening System

Cortex® is the only concealed fastening system that quickly, easily, and securely fastens AZEK Trim to your building project. No need to caulk, sand, and paint nail holes. Cortex comes with plugs made of AZEK® material (Classic White, PaintPro®, or matching any Cladding color) arranged on collated strips for a faster installation. Available in paintable smooth or woodgrain finish.



Product Finish Availability Smooth S Woodgrain W PaintPro P

SECTION HEADER

Exterior Moulding

With crisp, architectural details just like premium wood mouldings, high-performance AZEK® Moulding will last beautifully without the maintenance hassles associated with wood. Backed by the AZEK promise of high quality and lasting performance, our moulding will maintain its appearance despite the tests of time and weather. AZEK cellular PVC offers greater stability and predictability when fastening, and unlike traditional wood moulding, resists moisture and insect damage and will not rot or split.

BED MOULDING

Similar to crown moulding, a bed mould is used to cover the joint between the ceiling and wall.

RAMS CROWN

Consider installing rams crown at the top of a column or post, or use in place of a crown for a distinctive look.

CROWN MOULDING

Crown moulding is used for a classic look, bridging the corner between the wall and ceiling.

BAND MOULDING

Band moulding can be used alone or added to the base of a crown for a premium finish.

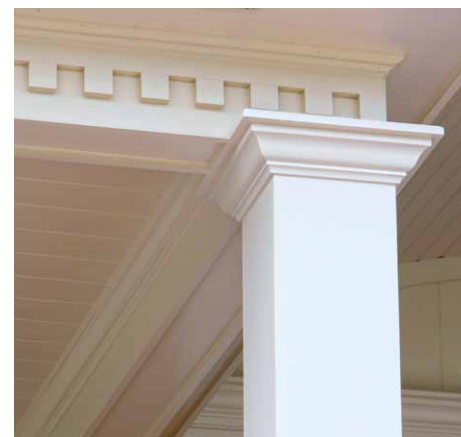

Crown Profiles

Crown moulding profiles are decorative mouldings designed for use along the intersection of a wall or ceiling. They may be combined with other mouldings to create a built-up profile.

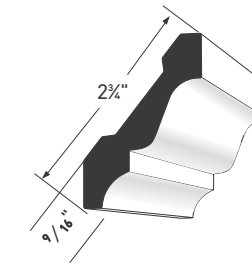

3" CROWN AZM-52
LENGTH: 16'

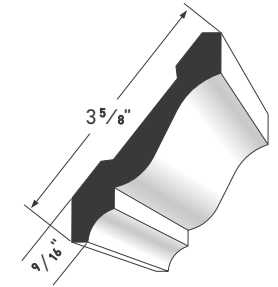

4" CROWN AZM-49
LENGTH: 16'

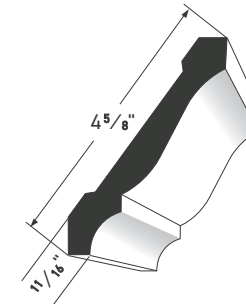

5" CROWN AZM-47
LENGTH: 16'

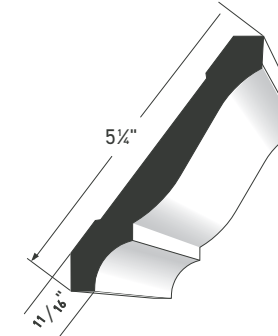

6" CROWN AZM-45
LENGTH: 16'

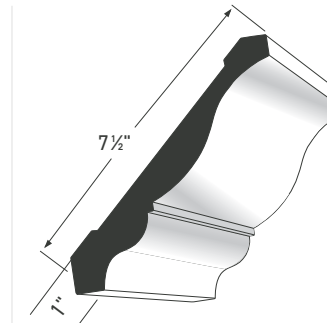

8" CROWN AZM-43
LENGTH: 16'

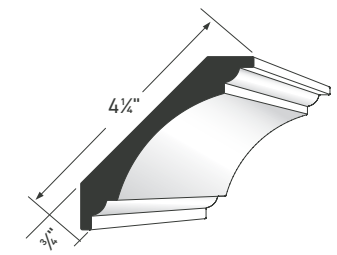

COVE MOULDING AZM-80
LENGTH: 16'

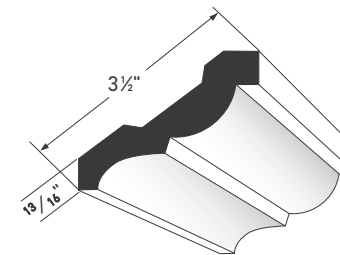

3 1/2" BED MOULDING AZM-28
LENGTH: 16'

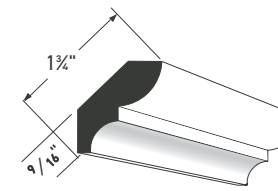

BED MOULDING AZM-75
LENGTH: 16'

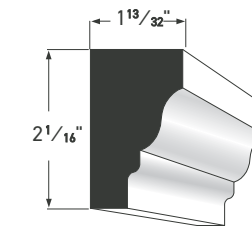

RAMS CROWN AZM-6934
LENGTH: 16'

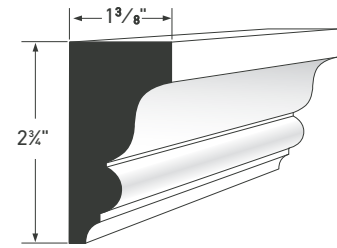

IMPERIAL RAKE CROWN AZM-6937
LENGTH: 16'

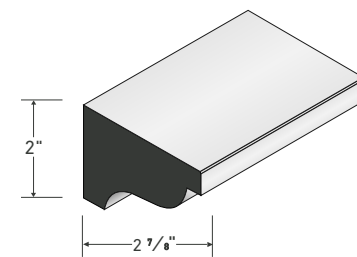

PEDIMENT CROWN MOULDING AZM-1882
LENGTH: 12'

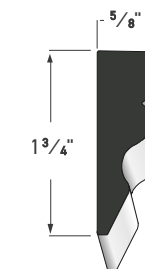

PANEL MOULD AZM-165
LENGTH: 16'

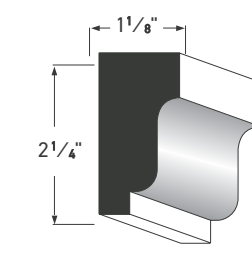

SOLID CROWN AZM-7954
LENGTH: 16'

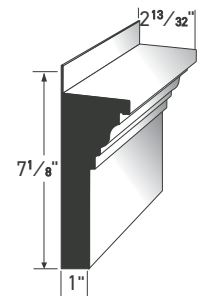

CROSSHEAD PEDIMENT AZM-6216
LENGTH: 18'

Detail and Sill/Drip Profiles

AZEK® Drip profiles can be used as a water table or brick ledge for separation and watershed against two different materials. AZEK Sill profiles shed water and offer architectural detail.

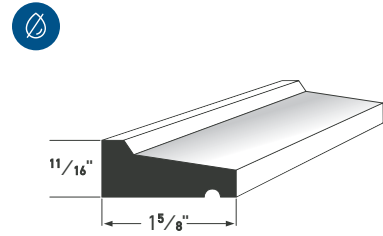
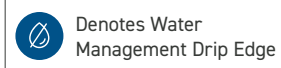

DRIP CAP AZM-197
LENGTH: 16'

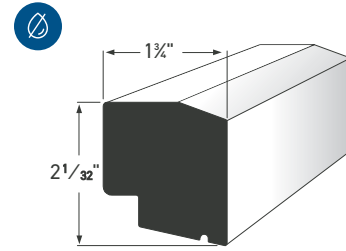

HISTORIC SILL AZM-6930
LENGTH: 16'

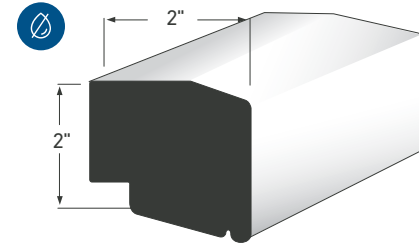

LARGE SILL NOSE AZM-7979
LENGTH: 16'

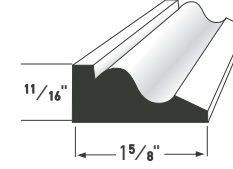

BAND MOULDING AZM-217
LENGTH: 16'

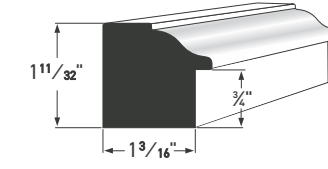

BACK BAND AZM-6931
LENGTH: 16'

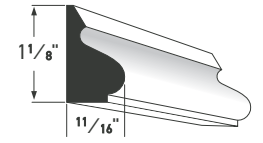

BASE CAP AZM-164
LENGTH: 16'

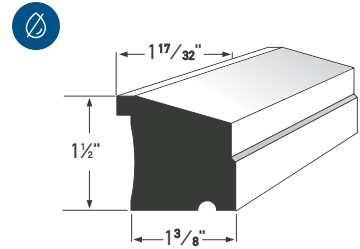

SUB SILL NOSE AZM-6933
LENGTH: 16'

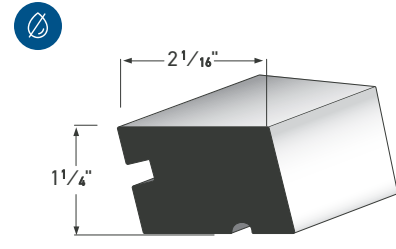

WINDOW SILL NOSE AZM-7974
LENGTH: 12'

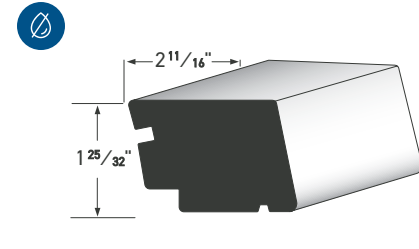

LARGE HISTORIC SILL AZM-7958
LENGTH: 16'

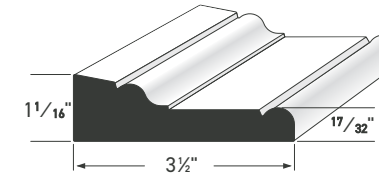

ADAMS CASING AZM-97
LENGTH: 16'

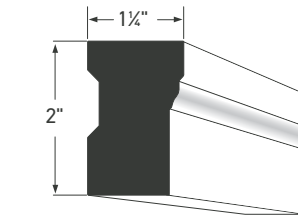

BRICK MOULD AZM-180
LENGTHS: 16' | 17' | 18''

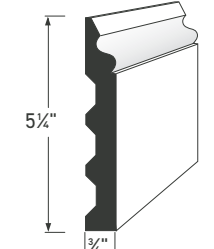

COLONIAL BASE CAP AZM-163
LENGTH: 16'

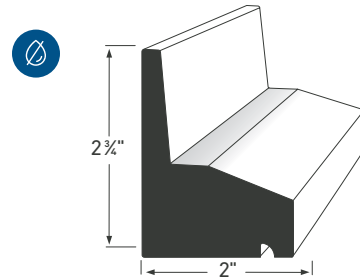

WATER TABLE AZM-6935
LENGTH: 18'

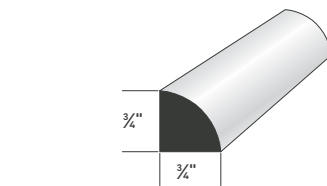

QUARTER ROUND AZM-105
LENGTH: 16'

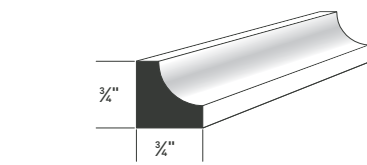

SCOTIA AZM-93
LENGTH: 16'

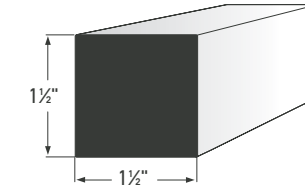

SQUARE PROFILE AZM-236
LENGTH: 12'

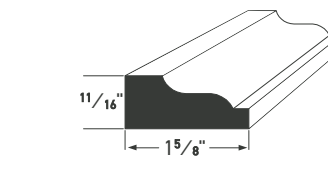

SHINGLE MOULD AZM-210
LENGTH: 16'

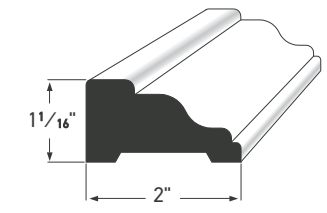

RAKE MOULDING AZM-287
LENGTH: 16'

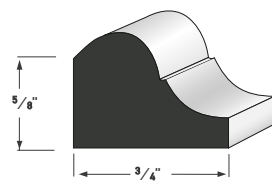

COVE AZM-7480
LENGTH: 16'

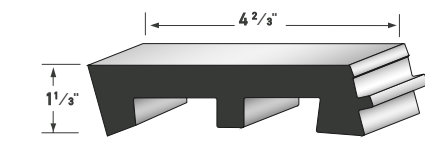

SILL AZM-948
LENGTH: 16'

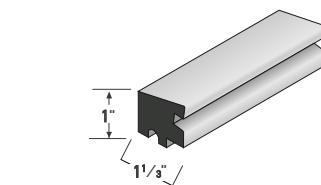

SILL NOSE AZM-937
LENGTH: 16'

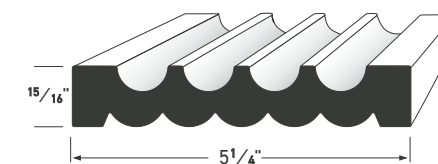

FLUTED/REEDED AZM-606
LENGTH: 16'

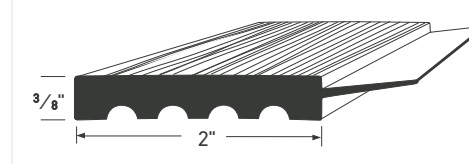

GARAGE DOOR THERMOSTOP AZM-6936
LENGTHS: 7' | 9' | 16'

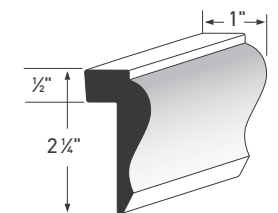

WAINSCOT CAP AZM-284
LENGTH: 16'





Casing Profiles

Use AZEK® Casing Profiles as decorative moulding against a wall, door, or window to create surrounds. Elevate your framing with style and durability.

*18' Brick Mould (AZM-180) is available in full units only and cannot be ordered via the Pick & Pack program.

Essential adhesives & fasteners

Description	SKU
 <p>Cortex Hidden Fastening System Cortex® is the only concealed fastening system that quickly, easily, and securely fastens AZEK® Trim to your building project. No need to caulk, sand, and paint nail holes. Cortex comes with plugs made of AZEK material on collated strips to make fastening faster.</p> <ul style="list-style-type: none"> • Classic AZEK Trim and PaintPro Trim • Paintable smooth or woodgrain finish 	220 ml: AAD220MLQM
 <p>Cellular PVC Cement Clear, contact-style adhesive bonds with PVC in a fast-working time. Ideal for securing joints. Creates a powerful and reliable material bond with no sanding or scraping required.</p> <ul style="list-style-type: none"> • 24-hour curing time • Clamp 24-48 hours for best results • Water-soluble for easy cleanup when surfaces are still wet • Convenient applicator built into lid • Use AZEK Adhesive to connect trim when a tight compression is required, such as connecting trim end-to-end (scarf joints) and at corners (miter joints) 	<p>Squeeze Bottle 4 oz: AADB004OZ 8 oz: AADB008OZ</p> <p>Container with Applicator 4 oz: AAD004OZ 8 oz: AAD008OZ 16 oz: AAD016OZ 32 oz: AAD032OZ 128 oz: AAD128OZ 640 oz: AAD640OZ</p>
 <p>Fast Cure</p> <ul style="list-style-type: none"> • White, two-part acrylic-based adhesive ideal for bonding AZEK to AZEK products; also bonds PVC to wood, metal, brick, vinyl, glass, and other PVC • Work time 4-7 minutes at 70°F after mixing with Qwik-Mixer; fully cures in 24 hours • Fills nail holes and gaps up to 1/8" • Requires Qwik-Mixer for easy mixing and dispensing 	220 ml: AAD220MLFCS 50 ml: AAD50MLFCS
 <p>Slow Cure</p> <ul style="list-style-type: none"> • White, two-part acrylic-based adhesive ideal for bonding AZEK to AZEK products; also bonds PVC to wood, metal, brick, vinyl, glass, and other PVC • Work time 15-25 minutes at 70°F after mixing with Qwik-Mixer; fully cures in 24 hours • Fill nail holes and gaps up to 1/2" • Requires Qwik-Mixer for easy mixing and dispensing 	220 ml: AAD220MLSCS 50 ml: AAD50MLSCS
 <p>Fill & Flex Use for expansion and contraction joints on PVC trim boards. Seals gaps around windows and doors. Slow curing, one-part urethane-based sealant with high level of flexibility and elongation to absorb expansion and contraction from heat or cold.</p> <ul style="list-style-type: none"> • Premium-grade TiO₂ pigments • Resists long-term yellowing • Allows ample work time 	300 ml: AAD300MLFF

Description	SKU
 <p>Manual 50 ML Dispense Gun Made of highly engineered plastic to be lightweight and powerful. Easy loading breech provides secure cartridge fit.</p>	AAD50MLMG
 <p>Manual 220 ML Dispense Gun Its 26:1 mechanical advantage dispenses high- and low-viscosity adhesives with less user fatigue. Designed to maximize durability.</p>	AAD220MLHF
 <p>Qwik-Mixers Required dispenser for Fast Cure and Slow Cure AZEK adhesive products. The resin and catalyst blend together as they travel down the tube to the applicator tip. Ensures 1:1 ratio mix and provides easy adhesive application. 24 per pack.</p>	50 ml: AAD50MLSQM 220 ml: AAD220MLQM
 <p>PVC Trim Nail Erasers Fills finish nail holes in PVC trim. White color perfectly matches AZEK trim. Resists yellowing.</p>	.5 oz: AADNEBLIS
 <p>Plastic Joining Biscuit PVC-compatible biscuits. Easy way to join, seal, and finish PVC Trim.</p>	Pack of 50: AADPJB

Industry-Leading Warranties

With decades in the business and dedicated investments to research and development, AZEK makes it our mission to provide the best materials on the market. We stand behind the integrity of our siding, cladding, trim, and moulding with a Lifetime Limited Warranty that covers corrosion, rotting, splintering, delamination, or swelling excessively from moisture. All AZEK products are also easy to maintain and resistant to mold, mildew, and moisture damage. For more information, visit AZEKexteriors.com/warranty.

Contractor and Builder Information

AZEK Trim, Siding, and Moulding and TimberTech® Cladding should be installed using the same good building principles used to install wood trim and mouldings and in accordance with the local building codes and established installation guidelines. AZEK accepts no liability or responsibility for the improper installation of AZEK products.

AZEK Siding, Trim, and Moulding may not be suitable for every application, and it is the sole responsibility of the installer to be sure that AZEK Siding, Trim, and Moulding, and TimberTech Cladding are fit for the intended use. Since all installations are unique, it is also the installer's responsibility to determine specific requirements in regard to each application. AZEK recommends that all applications be reviewed by a licensed architect, engineer, or local building official before installation.



Membership pays: count the benefits

EARN REWARDS

Earn program funds or cash back on AZEK® Trim and Siding and also on TimberTech® Decking and StruXure® Cabanas.

BUILD RECOGNITION

Take advantage of customizable ads, flyers, and other assets ready for your logo in our Marketing Technology Suite.

EXPAND YOUR NETWORK

Partner with industry leaders and boost business through our partner programs like JobTread, CompanyCam, and more.

STAY CONNECTED

Get access to our on-demand, best-in-class support team and exclusive training and networking opportunities.



JOIN TODAY
& START
EARNING



[AZEKexteriors.com](https://www.AZEKexteriors.com)

© 2026 AZEK Building Products LLC and its affiliates. All rights reserved.
LIT-PRODCAT-1125



THE SMART ALTERNATIVE TO VINYL



A BETTER CHOICE FOR YOUR HOME.

Whether you're replacing, remodeling or building, now you can bring Andersen beauty, craftsmanship and time-tested performance into your home for less than you may expect. Andersen® 100 Series windows and patio doors are made with our revolutionary Fibrex® composite material, which allows us to offer an uncommon value others can't. It's environmentally responsible and energy efficient, and it comes in durable colors that are darker and richer than most vinyl windows.

FIBREX®
MATERIAL IS
2X
STRONGER
THAN VINYL

LONG-LASTING* STRENGTH



Durable 100 Series products come with factory-finished interiors and exteriors that never need painting and won't fade, flake, blister or peel.*



**COLORS THAT
LAST***

Andersen® 100 Series windows come in beautiful, dark colors that will set your home apart.



Deep, rich colors, including Cocoa Bean, Dark Bronze and Black, complement virtually any architectural style.

MADE POSSIBLE BY OUR EXCLUSIVE FIBREX® MATERIAL

Fibrex® material is more than just environmentally responsible. It's also durable and beautiful. Here's what helps make Fibrex material so revolutionary:

- Fibrex material is **twice as strong as vinyl**, so weathertight seals stay weathertight.
- Our unique fabrication process **blends the color with the Fibrex material** for long-lasting beauty.
- It blocks thermal transfer nearly 700 times better than aluminum to help **reduce heating and cooling bills**.
- For **exceptional durability**, Fibrex material retains its stability and rigidity in all climates.

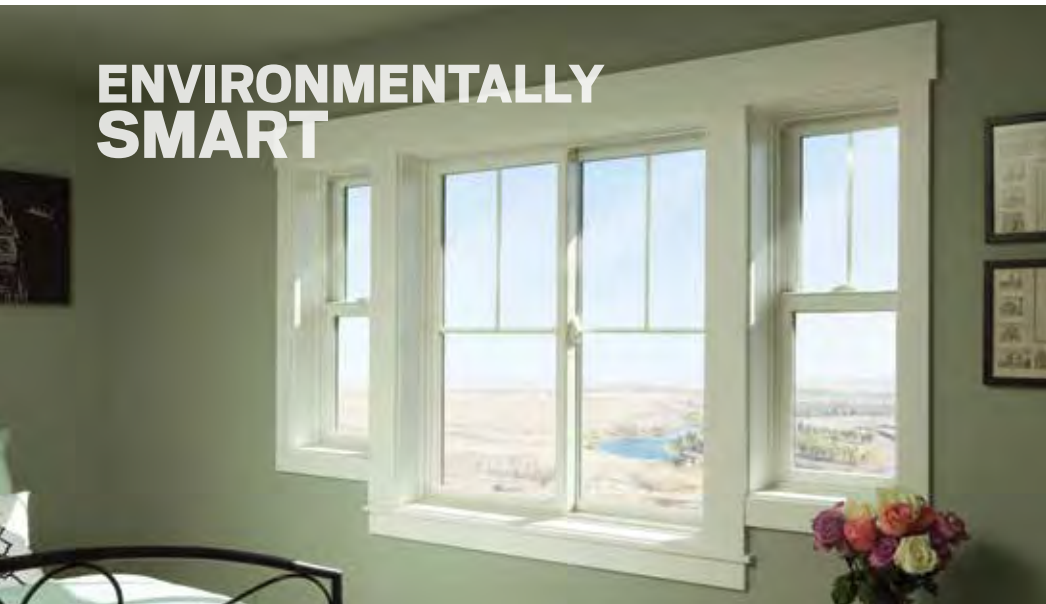

**ENVIRONMENTALLY
SMART**

100 Series products are made with our Fibrex composite material. It's composed of 40% reclaimed wood fiber by weight, most of which is created during the manufacture of Andersen wood windows.



40%
reclaimed wood fiber
by weight.



Learn more about Fibrex material by watching our video at andersenwindows.com/fibrex

WHY ANDERSEN® 100 SERIES WINDOWS & DOORS ARE AN EASY CHOICE.

All 100 Series windows and patio doors feature the performance, durability and ease of use you've come to expect from Andersen. Which means they not only provide energy efficiency, beauty and reliability today, but they'll also continue to add value to your home tomorrow and for years* to come. **Plus, they're virtually maintenance free.**



Existing
Cottage

REPLACEMENT

If you're thinking of replacement, think of 100 Series windows and patio doors. You'll find choices for virtually any project, and all feature energy-efficient designs that help keep energy bills to a minimum.



Custom sizes for
a weathertight fit.

100 Series windows and patio doors are available in custom sizes, which helps provide a more weathertight fit for any replacement project.

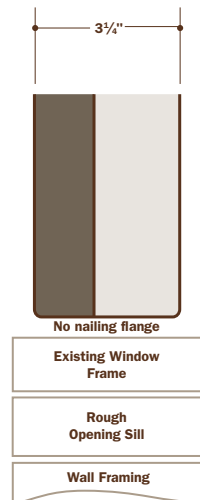

Replacement Configuration

This frame allows for fast and easy window replacement. Install the window into your existing window frame without disturbing interior or exterior trim, which saves you time and money.

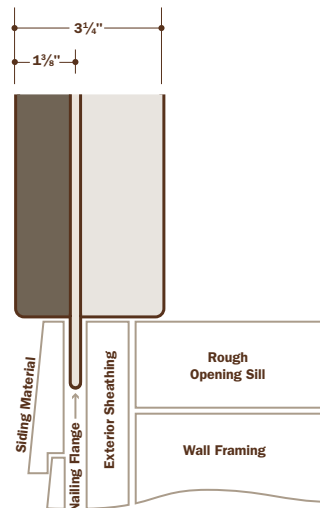

1 3/8" Flange Setback

The integral nailing flange makes it easy to install windows into a new opening and helps make sure the windows and doors are weathertight.

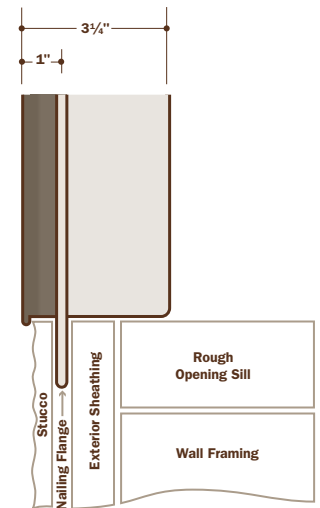

1" Flange Setback with Stucco Key

The integral nailing flange makes it easy to install windows into a new opening and helps make sure the windows and doors are weathertight. The stucco key eliminates gaps that can result from the natural contraction of exterior stucco.

ENVIRONMENTALLY SMART



Save money by saving energy.

Andersen® 100 Series products are available with glass options* that make them ENERGY STAR® certified, helping to **lower your heating and cooling bills**. What's more, the Fibrex® material used for 100 Series frames and sash blocks thermal transfer nearly 700 times better than aluminum.

It pays to understand performance.

Look for the National Fenestration Rating Council® (NFRC) performance information. It's your assurance you're getting accurate energy performance ratings from a nonpartisan, nonprofit organization. Here's what the numbers mean:

U-Factor measures the window's insulating capability. The lower the value, the less heat is lost through the entire product.

Visible Transmittance refers to how much visible light comes through a product. The higher the number, the better the visibility.

Solar Heat Gain Coefficient (SHGC) measures how well a product blocks heat from the sun. The lower the number, the more it helps reduce air conditioning bills.

Visit andersenwindows.com/100series for details.

STRENGTH

Easy operation for years to come.**

All 100 Series products are **tested to the extreme** to deliver years of smooth, reliable operation.**

Take comfort in superior weather resistance.

Our weather-resistant construction **seals out drafts, wind and water** so well, you can relax in comfort whatever the weather. We carefully select weatherstripping to match each style of window and door to make sure you enjoy superior comfort and reliability.

BEAUTY

Virtually seamless corners.

To give your windows, patio doors and your home a beautiful, clean look, Andersen 100 Series products feature virtually seamless corners.



100 Series corner seam



Welded vinyl corner seam



OWNER2OWNER® LIMITED WARRANTY

Quality so solid, the warranty is transferable.**

Most other window and door warranties end when a home is sold, but our coverage — 20 years on glass, 10 years on non-glass parts — transfers from each homeowner to the next. And, because it's not prorated, the coverage offers **full benefits, year after year, owner after owner**. So it can add real value when you decide to sell your home.

Never needs painting.

100 Series windows and doors **won't fade, flake, blister or peel,**** no matter what the climate.

Six colors for beautiful curb appeal.

From White and Sandtone to deep, rich Terratone, Cocoa Bean, Dark Bronze and Black colors, 100 Series windows and doors complement any home and any replacement project.

Improve your view with TruScene® insect screens.

With **over 50% more clarity** than conventional insect screens, optional TruScene® insect screens give you beautifully unobstructed views. They let more sunlight and fresh air into your home while keeping some of the smallest insects out.†

*Excludes units with capillary breather tubes. See your dealer for details.

**Visit andersenwindows.com/warranty for details.

†All comparisons made to conventional Andersen® insect screens.

CHOOSE THE WINDOWS, DOORS & OPTIONS THAT ARE RIGHT FOR YOU.

WINDOW & DOOR TYPES

Building an energy-efficient home doesn't mean you have to restrict your dreaming. Andersen® 100 Series windows and doors come in styles, shapes and even custom sizes to create the look you want.



SINGLE-HUNG WINDOWS

This style features a stationary upper sash that is also available with an arched top to enhance the look of your home.



CASEMENT & AWNING WINDOWS

Both styles open with a simple turn of a handle and can also be ordered as stationary windows.



GLIDING WINDOWS

These windows have one stationary sash and one that opens. A three-sash configuration, where two sash glide past a fixed center sash, is also available.



GLIDING PATIO DOORS

Patio doors feature one stationary panel and one that glides smoothly on adjustable rollers. They feature a multi-point locking system for enhanced security, and an optional exterior keyed lock for convenience. For more character, consider adding 100 Series sidelight windows on each side of your door and a transom window on top.



PICTURE & SPECIALTY WINDOWS

Arch, Springline™, half circle, quarter circle, full circle, and rectangle shapes are available to complement your home's architecture. New additional shapes include: angled pentagon, peak pentagon, right triangle, isosceles triangle, octagon, trapezoid and unequal leg arch.



Available in custom sizes to fit all projects, including replacement.

GLASS

Choose the right glass to maximize performance.

SMARTSUN™ GLASS

Low-E SmartSun™ glass is the most energy-efficient glass we have ever offered. It rejects unwanted solar heat to help reduce cooling costs and blocks 95% of UV rays that can cause your home furnishings to fade — all while providing a clear view.

LOW-E GLASS

Energy-efficient Low-E glass is available on all 100 Series products, and can help reduce energy bills in any climate.

HEATLOCK™ TECHNOLOGY

Our HeatLock™ coating can increase the energy efficiency of any 100 Series window or patio door with Low-E or SmartSun glass. Applied to the room-side glass surface, it reflects heat back into the home and improves U-Factors, which can help the window or door meet ENERGY STAR® requirements.

DUAL-PANE GLASS

Dual-pane glass is available for projects where codes allow its use.

SOUND-REDUCING GLASS

This glass option helps reduce the volume of outside noise. Available with Low-E, SmartSun and HeatLock coatings.

PATTERNED GLASS

Our patterned glass is ideal in bathrooms, entryways, offices and other areas where you want to let light into your home while obscuring the vision of people outside. It delivers all the benefits of Low-E glass and can also be ordered with Low-E SmartSun glass.

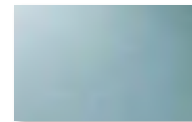

Obscure



Cascade

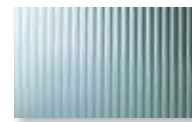

Reed



Fern

GRILLES

Customize the look of your windows and doors with these grille options.

Finelight™ grilles-between-the-glass make glass easy to clean. They have an elegant, sculpted profile, plus they offer a two-sided color scheme, allowing you to have grilles that match not only the interior but also your exterior color choice.

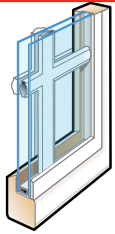

Finelight with Exterior Grilles make interior glass easier to clean, while permanent exterior grilles provide architectural style and detail.

For an authentic look, **Full Divided Lights** feature permanently applied grilles to the interior and exterior of the window with a spacer between the glass.

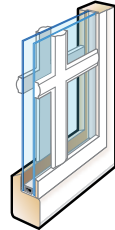
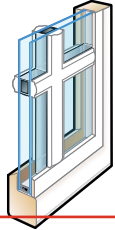

Simulated Divided Lights offer permanent grilles on the exterior and interior with no spacer between the glass.

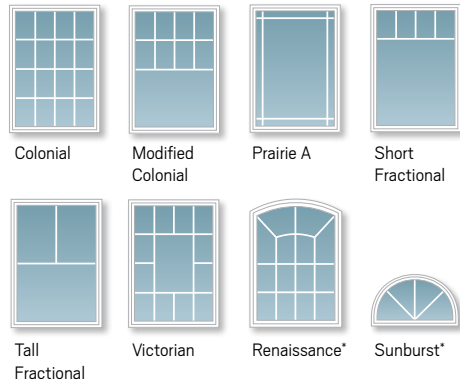

SPECIFIED EQUAL LIGHT
Any number of same-size rectangles across or down. Some limitations apply.

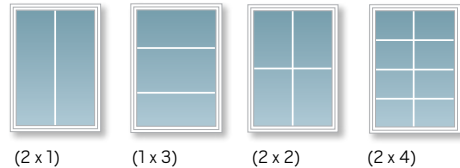

COLOR

Choose the right color to enhance the beauty of your home, inside and out.

EXTERIOR COLORS

Andersen® 100 Series products come in six exterior colors, including Black, Dark Bronze and Cocoa Bean — colors that are darker and richer than most vinyl windows.



INTERIOR COLORS

100 Series products feature an attractive matte finish inside. This gives you the ability to select your favorite exterior color without compromising options for interior decoration.

HARDWARE

You get attractive hardware that performs reliably for years!†

WINDOW HARDWARE



Single-hung and gliding windows feature hardware that automatically locks when windows are closed. Hardware color matches the window's interior.



Optional single-hung lift/pull handle matches the window's interior.



Optional metal Slim Line hardware is available in White, Sandtone, Dark Bronze, Black, Satin Nickel and Antique Brass.

Casement and awning hardware folds down so it doesn't interfere with window treatments and is available in White, Sandtone, Dark Bronze, Black, Satin Nickel and Antique Brass.



GLIDING PATIO DOOR HARDWARE

Tulsa hardware exterior handles match the door's exterior color, while interior handles match the interior. Afton hardware has the same finish inside and out. Also available, an optional auxiliary foot lock that secures the gliding panel in the track. It provides an extra measure of security when the door is in a locked position.

TULSA HARDWARE (Standard)

Exterior Handle

Interior Handle

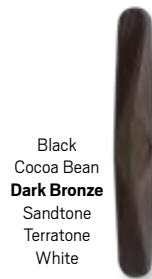

Black
Cocoa Bean
Dark Bronze
Sandtone
Terratone
White

Black
Dark Bronze
Sandtone
White

AFTON HARDWARE (Optional)

Exterior Handle

Interior Handle



Antique Brass
Black
Bright Brass
Satin Nickel

Bold name indicates finish shown.

*Renaissance and Sunburst patterns are only available with Finelight grilles. **Black and Dark Bronze interiors are only available with Black and Dark Bronze exteriors respectively. †Visit andersenwindows.com/warranty for details. Printing limitations prevent exact color duplication. See your Andersen dealer for actual color samples.

IMPROVING THE VIEW OUTSIDE.

Respect for the environment is nothing new at Andersen.

For more than a century, it's been part of who we are. Our commitment to recycle and reclaim materials began simply because it was good business. Now it's part of our commitment to sustainability and responsible stewardship of all our resources. Andersen Corporation is committed to providing you with long-lasting, energy-efficient windows and doors.



Andersen makes windows and doors with options that achieve **ENERGY STAR® 6.0** certification throughout the United States.



Andersen is a charter member of the **U.S. Green Building Council** and a strong supporter of its LEED® (Leadership in Energy and Environmental Design) Green Building Rating System.



Andersen was the first window and door manufacturer with **Green Seal™** certified products. Please visit our web site at www.andersenwindows.com for a list of certified products.

DON'T JUST TAKE OUR WORD FOR IT



Check out these customer testimonials at myAWstory.com



10% POST CONSUMER RECYCLED FIBER

WINDOWS • DOORS
Andersen® 

Come home to Andersen.®

andersenwindows.com/100series

Printed on FSC® certified paper, produced using Green-e certified renewable energy, with 10% post consumer recovered fiber.

"ENERGY STAR" is a registered trademark of the U.S. Environmental Protection Agency. All trademarks where denoted are marks of their respective owners. ©2016 Andersen Corporation. All rights reserved. 12/16 Part #9122169

BRIDGEPORT™ STEEL

garage doors

3-LAYER CONSTRUCTION



*Model BD2NU Shown in Standard White
with Plain Long Windows*



America's Favorite Garage Doors®

intellicore®

insulation technology

Clopay Bridgeport™ Steel garage doors featuring Intellicore® insulation technology represent the ultimate smart choice for homeowners. Clopay's Intellicore® insulation is a proprietary polyurethane foam that is injected into our Bridgeport™ Steel doors, expanding to fill the entire structure. The result is a door with incredible strength and durability. Its dense insulation also produces a quieter door, and with one of the industry's leading R-values of 18.4, it provides year-round comfort and improved energy efficiency.



WARMER

Energy efficiency provides year-round comfort



QUIETER

Dense insulation reduces noise by up to 16 decibels



STRONGER

Enhanced strength resists everyday wear and tear

BRIDGEPORT™ STEEL

garage doors

Bridgeport™ Steel garage doors combine the traditional symmetry of wood stile and rail door designs with the proven durability of Clopay's three-layer steel construction. This provides exceptional strength and energy efficiency as well as quiet operation. The 2" or 1-3/8" thickness of Intellicore® polyurethane insulation with a thermal break makes these doors heat and cold resistant while the tongue-and-groove joint helps seal out wind, rain and snow. Available in narrow and extended recessed panel designs with multiple window options, three-layer Bridgeport™ Steel garage doors are virtually maintenance-free making the beautiful look a lasting impression.

3-LAYER CONSTRUCTION

- Tongue-and-groove section joints help seal out wind, rain and snow.
- Replaceable vinyl bottom weatherseal in a rust-resistant aluminum retainer helps seal out the elements.
- 2" and 1-3/8" Intellicore® insulation filled doors come standard with 10-ball nylon rollers and heavy-duty 14 gauge steel hinges.
- Prepainted Standard White end stiles and interior steel backing create a clean, finished appearance.
- 2" and 1-3/8" Intellicore® insulation filled doors comply with 2015 IECC air infiltration requirement of 0.40 cfm/ft² or less (IECC, Section C402.5.2).



**BD2NU
& BD2EU
MODELS**



**BD1NU
& BD1EU
MODELS**



*Calculated door section R-value is in accordance with DASMA TDS-163.
Models with Ultra-Grain® finish and Black paint options are 25 gauge steel.*

TRADITIONAL shaker style versatile design CHOICES



Model BD2EU; Shown in Sandtone with SQ24 Windows

DETAIL



A true recessed stamp replicates the timeless look of a rail and stile built wood door.

STYLE



Narrow

Models BD1NU and BD2NU.



Extended

Models BD1EU and BD2EU.

Smooth-Star®



Smooth, paintable surfaces.

Smooth-Star is the answer when the best look for the home is delivered in a sleek, paintable package. The more attractive and durable alternative to steel, Smooth-Star fiberglass doors are ready-to-paint with crisp, clean contours that meet the needs of homeowners seeking more color options for their doorways.

Fiber-Classic® & Smooth-Star® Fiberglass Doors

Therma-Tru gives the homeowner options to choose the style that best fits their personality and home without compromise. Fiber-Classic and Smooth-Star share many door styles in common. And the available glass families cross over between door collections. Find flexible options to fit virtually every entrance from front entry to patio to utility doors.



Fiber-Classic & Smooth-Star fiberglass doors offer:

- High-definition panel embossments.
- Composite top and bottom rails.
- 1-1/4" engineered lumber lock stiles.
- 22-1/2" lock block in Fiber-Classic and 12-1/2" lock block in Smooth-Star.
- Durable, long-lasting fiberglass skins.

6 WBDR Options: Look for this icon to find door styles that can be configured for WBDR.*

6 WBDR / HVHZ Options: Look for this icon to find door styles that can be configured for WBDR or HVHZ.*

🔥 Fire-rated options available on solid-panel doors. See pages 230–235.

Warranty Riders

🔥 See page 31 for details on the EnLiten™ Flush-Glazed Rider for Construction & Installation, and the EnLiten™ Flush-Glazed Rider for Homeowners.

+ Tru-Defense® Warranty Rider eligible when properly assembled and installed with all Therma-Tru specified system components, in accordance with the Rider.



**Fiber-Classic®
Mahogany
Collection™**

Features deep Mahogany graining to complement homes with richer wood tones.



**Fiber-Classic®
Oak Collection™**

Features the warm look and feel of Oak graining.





Smooth-Star®

Features smooth, ready-to-paint surfaces.

*Please verify that there is a Therma-Tru Impact-rated product approval for the configuration before buying. Note: Finish colors may vary from an actual application due to fluctuations in finishing or printing. See your Therma-Tru seller or visit www.thermatru.com for more, including details on limited warranties and exclusions, Riders, ENERGY STAR qualified products and product approvals.

Simulated Divided Lites (SDLs) with Grilles Between Glass (GBGs)

Choose wood-grained or smooth-textured SDL bars layered over flat bronze GBG bars to achieve the most authentic divided lite look.

Look for the ( ) icons.



Shown with flat bronze GBGs, recommended.

Simulated Divided Lites (SDLs)

Wood-grained or smooth SDL bars are adhered to the interior and exterior panes of tempered glass. Can be stained or painted any color to complement the door and home.

Look for the ( ) icons.



Grilles Between Glass (GBGs)

Contour or flat GBG bars are thermally sealed between two panes of tempered glass for the convenience of a smooth, easy-to-clean glass surface.

Look for the () icon.



Removable Wood Grilles

Removable wood grilles snap on and off the interior pane of tempered glass for easy cleaning. Can be stained or painted to complement the home décor.

Look for the () icon.



Interior view.

*Available in Special Quote Program.
Note: See page 275 for important product details that may help with your purchase decision.
Right Page: Smooth-Star, Clear Glass with SDLs, Door – S82103, Sidelites – S8000SL

Fixed Grilles



Fixed grilles are molded as part of the lite frame on the interior and exterior panes of tempered glass. Can be stained or painted to complement the home décor.

Look for the (◆) icon.



SDL Bar Options

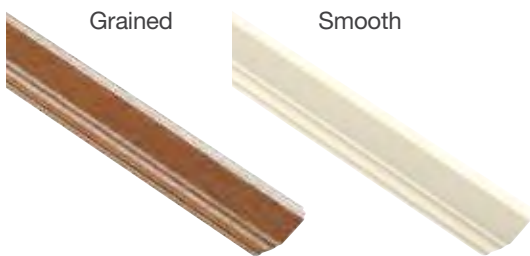

Grained

Smooth

(28.6 mm / 1.125 in.)
Look for the (1) icon.



Smooth

(28.6 mm / 1.125 in.)
Look for the (1) icon.



Grained

Smooth

(88.9 mm / 3.5 in.)
Look for the (2) icon.

GBG Bar Options

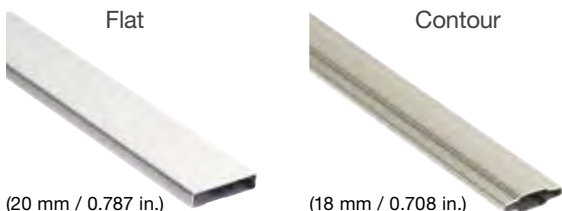

Flat

Contour

(20 mm / 0.787 in.)

(18 mm / 0.708 in.)

GBG Color Options

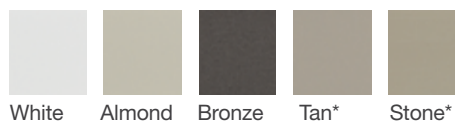

White

Almond

Bronze

Tan*

Stone*

Key

- Simulated Divided Lites (SDL)
- Simulated Divided Lites (SDLF1)
- Simulated Divided Lites (SDLF2)
- Flat or Contour, White or Color Grilles Between Glass (GBGF / GBGC)
- Removable Wood Grilles (RG)
- Fixed Grilles (FXG)

MA MID-AMERICA
Siding Components®



Louver Shutters



Standard Cathedral Open Louver Master Shutter®

20 Colors 001, 002, 004, 008, 009, 010, 018, 023, 027, 028, 036, 078, 117, 122, 166, 167, 282, 283, 284, 285 and paintable (030)

Custom Color Program
Master Shutter series can be produced in any color that Mid-America manufactures. For more information on our Custom Color Program, see page 50.

Widths 12" and 14 1/2"
(widths are nominal)

Lengths 25", 31", 36", 39", 43", 48", 52", 55", 60", 64", 67", 72", 75", & 80" (lengths are nominal)

Packaged Boxed pairs with Shutter-Lok® fasteners. Shutters 43" and under receive 8 pack of Shutter-Loks. Shutters over 47" receive 12 pack.



SIZE	ITEM #
12" x 25"	00 01 1225 ***
12" x 31"	00 01 1231 ***
12" x 36"	00 01 1236 ***
12" x 39"	00 01 1239 ***
12" x 43"	00 01 1243 ***
12" x 48"	00 01 1248 ***
12" x 52"	00 01 1252 ***
12" x 55"	00 01 1255 ***
12" x 60"	00 01 1260 ***
12" x 64"	00 01 1264 ***
12" x 67"	00 01 1267 ***
12" x 72"	00 01 1272 ***
12" x 75"	00 01 1275 ***
12" x 80"	00 01 1280 ***

SIZE	ITEM #
14 1/2" x 25"	00 01 1425 ***
14 1/2" x 31"	00 01 1431 ***
14 1/2" x 36"	00 01 1436 ***
14 1/2" x 39"	00 01 1439 ***
14 1/2" x 43"	00 01 1443 ***
14 1/2" x 48"	00 01 1448 ***
14 1/2" x 52"	00 01 1452 ***
14 1/2" x 55"	00 01 1455 ***
14 1/2" x 60"	00 01 1460 ***
14 1/2" x 64"	00 01 1464 ***
14 1/2" x 67"	00 01 1467 ***
14 1/2" x 72"	00 01 1472 ***
14 1/2" x 75"	00 01 1475 ***
14 1/2" x 80"	00 01 1480 ***

Custom Style-A-Louver™ Shutters

18 Colors 001, 002, 004, 008, 009, 010, 016, 018, 020, 023, 027, 028, 036, 078, 117, 122, 166, 167 and paintable (030)

4 Colors 282, 283, 284, and 285 available for styles L1 and L2 in Widths 9 1/4", 12", 14 1/2" and Lengths 25"-80" only.

Widths 5 3/4", 8 1/2", 9 1/4", 11", 12", 13", 14 1/2", 16 1/2", 18"
(widths are nominal)

Lengths 18" to 144" (in 1/4" increments – lengths are nominal)

Double Widths
Widths 20 1/4", 25 1/2", 29 1/2", 31"
Lengths 18"-120"
(widths & lengths are nominal)

Packaged Boxed pairs with Shutter-Lok® fasteners. Custom shutters receive 12 pack of Shutter-Loks.



L1
Cathedral Top
Center Mullion



L2
Straight Top
Center Mullion



L3
*Cathedral Top
Offset Mullion

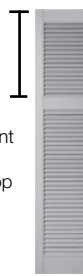

L4
*Straight Top
Offset Mullion

* Measurement from top of shutter to top of mullion necessary.



L5
Cathedral Top
All Louver



L6
Straight Top
All Louver



L7
Straight Top
Double Wide

Color Program

SHUTTER COLOR PROGRAM

STANDARD SHUTTERS

Standard Cathedral Open Louver Master Shutter® and Standard Williamsburg Raised Panel Master Shutter®

20 Colors 001, 002, 004, 008, 009, 010, 018, 023, 027, 028, 036, 078, 117, 122, 166, 167, 282, 283, 284, 285 and paintable (030)

Custom Color Program:

Master Shutter series can be produced in any color that Mid-America manufactures. This program is designed to provide color options on large scale projects. Minimum order size of 100 pairs per color, per size. Different size shutters cannot be combined to achieve the minimum order. Custom Color orders have a 4 week lead time. Custom Color orders are non-cancelable and non-returnable. An upcharge applies to Custom Color orders, please see price book for more information.

Standard Board-N-Batten™ Shutters

20 Colors 001, 002, 004, 008, 009, 010, 018, 023, 027, 028, 036, 078, 117, 122, 166, 167, 282, 283, 284, 285 and paintable (030).

CUSTOM SHUTTERS

Custom Style-A-Louver™ Shutters

18 Colors 001, 002, 004, 008, 009, 010, 016, 018, 020, 023, 027, 028, 036, 078, 117, 122, 166, 167 and paintable (030)

4 Colors 282, 283, 284, and 285 available for styles L1 and L2 in Widths 9¼", 12", 14½" and Lengths 25"- 80" only.

Custom Style-A-Panel™ Shutters

18 Colors 001, 002, 004, 008, 009, 010, 016, 018, 020, 023, 027, 028, 036, 078, 117, 122, 166, 167 and paintable (030)

4 Colors 282, 283, 284, and 285 available in Widths 9¼", 12", 14½" and Lengths 31"- 80" for P2 only

Custom Louver-Panel Combination Shutters

18 Colors 001, 002, 004, 008, 009, 010, 016, 018, 020, 023, 027, 028, 036, 078, 117, 122, 166, 167 and paintable (030)

Custom Board-N-Batten™ Shutters

18 Colors 001, 002, 004, 008, 009, 010, 016, 018, 020, 023, 027, 028, 036, 078, 117, 122, 166, 167 and paintable (030)

4 Colors 282, 283, 284, and 285 Widths 3 Board Spaced - 12" only, 4 Board Joined - 14" only, (not available in style J4-A) Lengths 30"-80" only. J4-A Lengths 45"-94" only

MOUNT BLOCK UTILITY VENT COLOR PROGRAM

FULL COLOR OFFERING

Available in our full color offering. Ask to see color keychain for selection.

- All Mount Blocks including Standard, Fiber Cement, Insulated Siding
- All Utility Vents including Standard, Fiber Cement, Insulated Siding except Foundation Master which is available in 24 colors plus paintable.

* Orders under \$150.00 are subject to a Small Order Quantity charge. See Price Book for details.

DECOR COLOR PROGRAM

9 STANDARD COLORS

Available in 9 standard colors plus paintable (030) with standard lead-times.

Note Also available in our full color offering with a 25-piece minimum and a lead-time of 10 days.

9 Colors 001, 002, 008, 023, 028, 034, 078, 117, 123 and Paintable (030)

- Headers:** Sizes can be combined, both standard and custom, to equal the 25 piece minimum. The 9"x128" Header and any width over 144" along with any width over 73: in a 6" or 9" with endcaps are only available in 001, 117, 123 and 030.
- Door Surrounds**
- Sunbursts**
- Pilasters**
- Scallop & Square Exterior Dentil Trim:** Trim only requires a 4 box minimum for orders outside of the 9 standard colors. For Dentil outside corners & inside corners, the 25 piece minimum does not apply.

GABLE VENT COLOR PROGRAM

STANDARD LEAD TIME: 10 BUSINESS DAYS

	Full Color Offering No Minimum	24 Master Colors + Paintable	25 Piece Minimum Full Color Offering
Round Top			
14" x 22"		•	•
22" x 32"		•	•
Oval			
21" x 27"		•	•
Octagon			
18"	•		
22"	•		
27"		•	•
32"		•	•
Round			
18"	•		
22"	•		
36"		•	•
30" Round w/ Keystones		•	•
28" Round w/o Keystones		•	•
Half Round			
34" x 22"	•		
Rectangle / Square			
12" x 12" Square	•		
12" x 18" Classic Style	•		
12" x 18" Replacement Vent		•	•
18" x 24" Classic Style		•	•
18" x 24" Rectangle	•		
24" x 30" Classic Style		•	•

24 MASTER COLORS INCLUDE

001, 002, 008, 011, 012, 013, 016, 020, 021, 023, 028, 034, 045, 048, 049, 069, 078, 082, 085, 089, 095, 097, 117, 123 and Paintable (030). Style-A-Vents & Specialty Vents are only available in 001 and paintable. Can not combine different vents or colors to equal the 25 piece minimum.

Ordering

ITEM NUMBERS MAKE ORDERING EASY!

Item Numbers were designed to simplify the ordering process. They eliminate confusion and allow for orders to be processed quicker. The exact style, size and color are clarified within each number.

Most Item Numbers are 11 digits long. Here's an example of a product and its corresponding item number:

Item Number	Description
00 01 1425 028	14½" x 25" Cathedral Open Louver Master Shutter® in Forest Green

This is how the number is broken down:

- 00 01 1425 028** The first two digits indicate the category number. Most Item Numbers begin with "00".
- 00 01 1425 028** The next two digits signify the product category. In this case, "01" stands for "Cathedral Open Louver".
- 00 01 1425 028** The following four digits are the description number. In this case, "1425" represents the size 14½" x 25".
- 00 01 1425 028** The last three digits are the color number. "028" is the number for Forest Green.

If a product is available in more than one color, the color number will be shown with 3 asterisks (i.e. 00 01 1425 ***). Simply insert your chosen 3-digit color number in place of the asterisks. Products that are only available in one color will have the color number completed for you (i.e. 00 97 0642 002).

		
White 001	Black 002	Wedgewood Blue 004
		
Clay 008	Federal Brown 009	Musket Brown 010
		
Bright White 117	Tuxedo Grey 018	Wicker 023
		
Burgundy Red 027	Forest Green 028	Parchment 034
		
Classic Blue 036	Wineberry 078	Midnight Green 122
		
Midnight Blue 166	Bordeaux 167	Colonial Green 282*
		
Moss 283*	Sage 284*	Plum 285*
	* See color program page for availability	
Paintable 030		

MID-AMERICA PLANT ORIGATION KEY

PLANT ORIGATION KEY	Metamora MI	Elkland PA	Franklin OH
Master Shutters®/Standard			
12" Cathedral Open Louver	M		
12" Williamsburg Raised Panel	M		
14 1/2" Cathedral Open Louver		E	
14 3/4" Williamsburg Raised Panel		E	
12" & 14" Board-N-Batten™	M		
Custom Shutters			
Board-N-Batten™	M		
Style-A-Louver™	M		
Style-A-Panel™	M		
Shutter Tops			
Quarter Round Arch Tops			
14 1/2" Open Louver		E	
14 1/2" Solid		E	
14 3/4" Fanfold		E	
14 3/4" Raised Panel		E	
12" Raised Panel		E	
14 3/4" Transom Top Add On		E	
12" Transom Top Add On		E	
6" Elliptical Arch Top		E	
Window and Door Trim			
Headers		E	
Header Keystones		E	
Sunbursts		E	
Pilaster Kit for Door Surround		E	
Dentil Trim		E	
Oval & Octagon Windows	M		
Gable Vents			
GableMaster® Stock Vents		E	
Gable Vent Keystones		E	
GableMaster® Specialty Vents	M		
GableMaster® Style-A-Vent™	M		
Mount Blocks			
All Mount Blocks		E	
Utility Vents			
FoundationMaster™		E	
Animal Guards		E	
Master Exhaust Vent		E	
Master Intake/Exhaust Vent		E	
Classic Hooded Vent		E	
Accessories			
Decorative Hinge & S-Hook		E	
Shutter-Lok®	M/E	M/E	
Painted Steel Screws	M/E	M/E	
Address Kit Accessories		E	
Specialty Shapes			F
IQ™ Trim Board			F
Roof Ventilation	M		

Avalon Aluminum Railing®



Rust-resistant Avalon Aluminum Railing provides style, versatility and safety. The pre-assembled rail panels feature ProLock® locking strips that are designed to hold balusters securely in place. The ultimate in customization, Avalon Aluminum Railing offers three top rail options, including an adapter piece that easily creates a distinctive 3 rail design.



ProLock®

ProLock is a locking strip that secures railings by connecting them from the inside out to provide a clean design.

- Cable and glass slat infill options provide unobstructed views
- Panels with square balusters come pre-assembled
- Premium powder coating on aluminum framing meets and exceeds AAMA 2604 specifications
- Advanced weather testing, including 10,000 hours of salt spray testing
- Assembled in the USA with Transferable Limited Lifetime Warranty



Matte Black



Matte Bronze



White



How to Shop:

Cable Infill

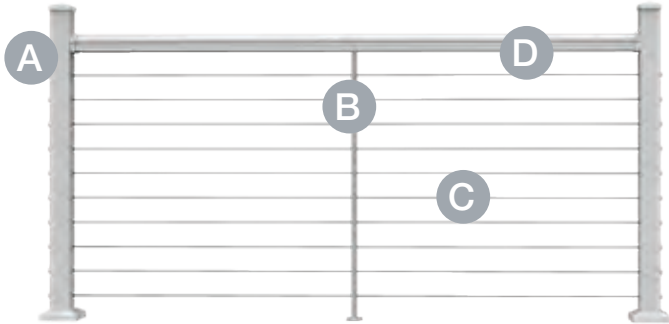

A Pick Your Posts

Routed cable posts – end, mid and corner options (includes base and post cap).

B Pick Your Beam Kit

Includes top beam, 4 brackets and mid-baluster support.

C Pick Your Infill

Cable with fitting – 10 needed for 36" finished heights, 12 needed for 42" finished heights. Available in 10', 20', 30', 50' and 70' lengths.

D Pick Your Top Rail

Required to complete installation – select from 3 styles.

Square Balusters

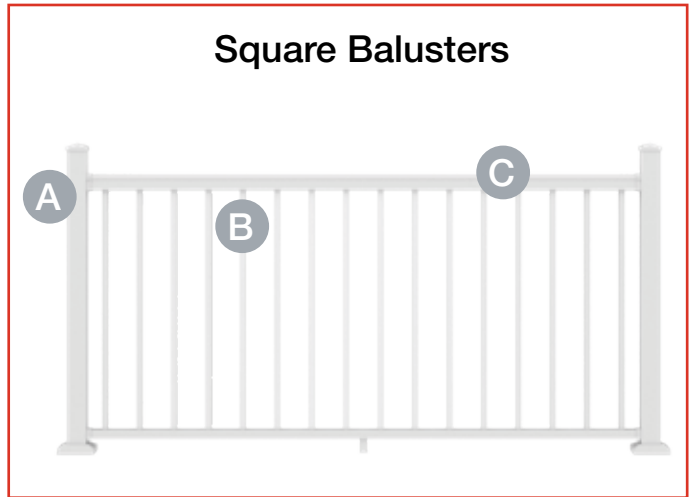

A Pick Your Posts

Standard aluminum posts – 2½" (includes base and post cap) or 4¼" (base and post cap sold separately) options.

B Pick Your Rail Panel

Pre-assembled level and stair rail sections. Includes 4 brackets and a support foot.

C Pick Your Top Rail

Required to complete installation – select from 3 styles.

Decorative Screen Panel Infill



Glass Slats (Level Only)

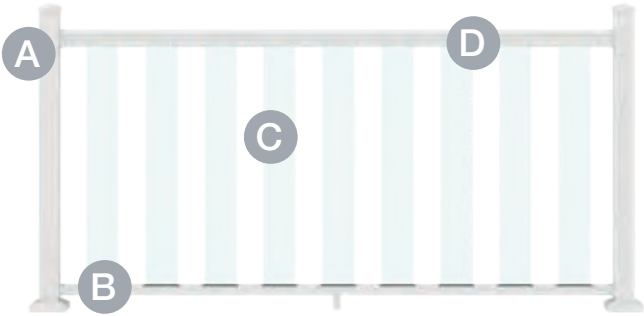

A Pick Your Posts

Standard aluminum posts – 2½" (includes base and post cap) or 4¼" (base and post cap sold separately) options.

B Pick Your Beam Kit

Includes top beam, bottom rail, Decorative Screen Panel uprights, brackets and support foot.

C Pick Your Infill

3' x 6' Decorative Screen Panel infill – available in 4 styles and a variety of color combinations (sold separately).

D Pick Your Top Rail

Required to complete installation – select from 3 styles.

A Pick Your Posts

Standard aluminum posts – 2½" (includes base and post cap) or 4¼" (base and post cap sold separately) options.

B Pick Your Beam Kit

Available in 6' and 8' for 36" and 42" finished heights, level only. Includes 4 brackets and support foot.

C Pick Your Infill

Glass slat infill – 9 needed for 6' sections, 12 needed for 8' sections. Available for 36" and 42" finished heights, level only.

D Pick Your Top Rail

Required to complete installation – select from 3 styles.

Aluminum 2½" x 2½" Routed Cable Posts			
Description	White	Matte Black	Matte Bronze
2½" x 2½" x 39" End Post	73042977	73042976	73042978
2½" x 2½" x 39" Mid Post	73042983	73042982	73042984
2½" x 2½" x 39" Corner Post	73042995	73042994	73042996
2½" x 2½" x 39" Top Stair Post	73050039	73050038	73050040
2½" x 2½" x 42" Bottom Stair Post	73045616	73045615	73045617
2½" x 2½" x 42" Mid Stair Post	73050045	73050044	73050046
2½" x 2½" x 45" End Post	73042980	73042979	73042981
2½" x 2½" x 45" Mid Post	73042986	73042985	73042987
2½" x 2½" x 45" Corner Post	73042998	73042997	73042999
2½" x 2½" x 45" Top Stair Post	73050042	73050041	73050043
2½" x 2½" x 48" Bottom Stair Post	73045619	73045618	73045620
2½" x 2½" x 48" Mid Stair Post	73050048	73050047	73050049
2½" x 2½" x 52" Fascia End Post	73045622	73045621	73045623
2½" x 2½" x 52" Fascia Mid Post	73045628	73045627	73045629
2½" x 2½" x 52" Fascia Corner Post	73045625	73045624	73045626
2½" x 2½" x 52" Fascia Top Stair Post	73050051	73050050	73050052
2½" x 2½" x 55" Fascia Bottom Stair Post	73050079	73050077	73050080
2½" x 2½" x 55" Fascia Mid Stair Post	73050054	73050053	73050055

42" stair posts are designed to work with 39" top stair posts. 48" stair posts are designed to work with 45" top stair and level posts. 52" and 55" posts are for 42" fascia applications only.



Routed End Post

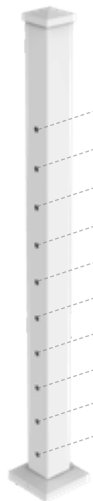

Routed Mid Post



Routed Corner Post

Use end, mid and corner posts for level applications. End posts have routed holes through post to anchor fitting at an end run of cable. Stair and fascia posts are also available. Posts include post, connected base plate, sandwich plate, trim ring and post cap.

Cable Rail Beam Kits

Description	White	Matte Black	Matte Bronze
6' x 36" Level Rail Beam Kit for Cable Rail	73042965	73042964	73042966
8' x 36" Level Rail Beam Kit for Cable Rail	73042968	73042967	73042969
6' x 42" Level Rail Beam Kit for Cable Rail	73050027	73050026	73050028
8' x 42" Level Rail Beam Kit for Cable Rail	73050030	73050029	73050031
6' Stair Rail Beam Kit for Cable Rail	73050033	73050032	73050034
8' Stair Rail Beam Kit for Cable Rail	73050036	73050035	73050037

Stair beam kits can accommodate both 36" and 42" finished heights. See product instructions for details. Cable components and Top Rail sold separately. See page 16 for Top Rail styles.

Cable Components

Description	
10' Cable with Fitting – Package of 1	73042960
20' Cable with Fitting – Package of 1	73042961
30' Cable with Fitting – Package of 1	73042962
50' Cable with Fitting – Package of 1	73042963
70' Cable with Fitting – Package of 1	73050296
Level Cable Lacing Needle	73050056
Corner Cable Lacing Needle	73050057
Cable Release Key	73025484
Cable Gripper Tool – Package of 2	73050244
E-Z Clean Cable Cleaner and Protectant	73040274

For a finished rail height of 36", 10 packages of cable with fitting will be needed. For a finished rail height of 42", 12 packages of cable with fitting will be needed.

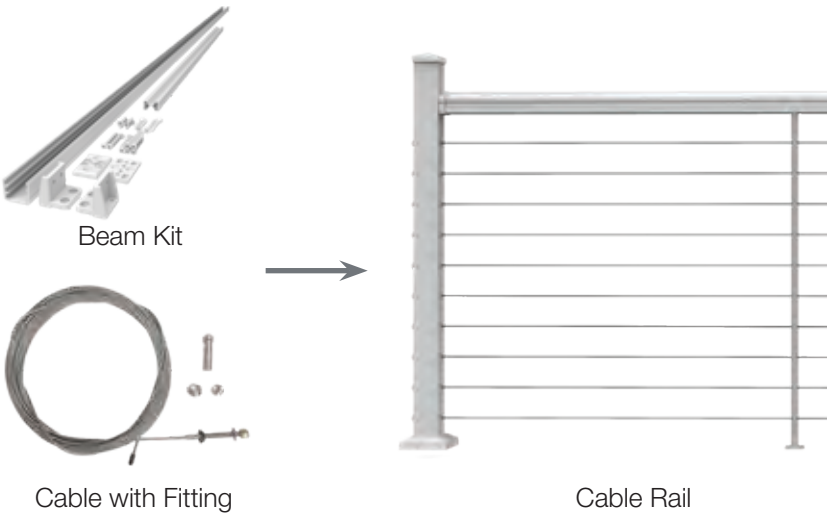

Avalon Aluminum Railing®

Aluminum 2½" x 2½" Standard Posts			
Description	White	Matte Black	Matte Bronze
2½" x 2½" x 39" Post	73043054	73043046	73043050
2½" x 2½" x 45" Post	73043055	73043047	73043051
2½" x 2½" x 45" Heavy Duty Post	73043056	73043048	73043052
2½" x 2½" x 60" Heavy Duty Post	73043057	73043049	73043053
2½" x 2½" x 45" Fascia Mount Post*	73045504	73045503	73045505
2½" x 2½" x 52" Fascia Mount Post*	73045501	73045500	73045502
2½" x 2½" x 65" Post Extension	73050521	73050520	73050522

Standard posts include post, connected base plate, sandwich plate, trim ring and post cap.

*Brackets to install fascia mount posts for end, mid or corner applications sold separately. See page 18 for fascia brackets.

Post Extension fits into 2½" standard posts to extend the height of the post to allow for patio lights to be hung above the railing.

2" x 2" Over-the-Top Posts			
Description	White	Matte Black	Matte Bronze
2" x 2" x 33" Over-the-Top Post (for 36" finished height)	73020642	73020646	73019470
2" x 2" x 39" Over-the-Top Post (for 42" finished height)	73020643	73020647	73019471

Avalon panels must be cut up to 4" shorter than top rails pending install application. For 42" commercial height, over-the-top spans cannot exceed 5' in length between posts. Brackets sold separately – see page 18.

Aluminum 4¼" x 4¼" Posts/Sleeves			
Description	White	Matte Black	Matte Bronze
4¼" x 4¼" x 39" Post	73041379	73041378	73041376
4¼" x 4¼" x 45" Post	73041383	73041382	73041380
4¼" x 4¼" x 108" Porch Post – 5,000 lb capacity	73041375	73041374	73041372

4¼" x 4¼" x 108" post sleeves can be used as porch columns (5,000 lb load capacity); two mounting kits will be needed in this application.

Aluminum 4¼" x 4¼" Post/Sleeve Accessories			
Description	White	Matte Black	Matte Bronze
Flat Post Cap for 4¼" x 4¼" Posts	73041367	73041366	73041364
Trim Ring for 4¼" x 4¼" Posts	73041371	73041370	73041368
Mounting Kit for 4¼" x 4¼" Posts (includes trim ring and mounting plate)	73041363	73041362	73041360

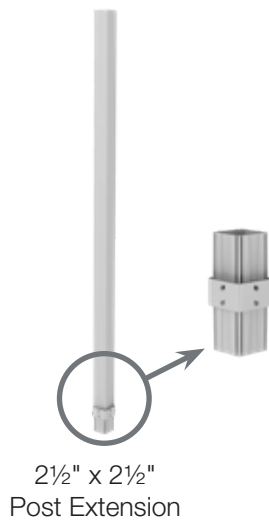
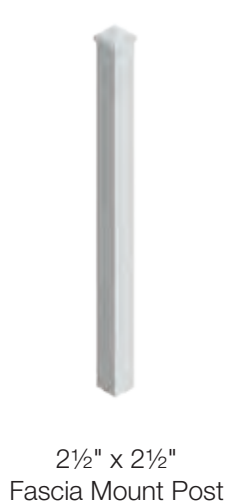
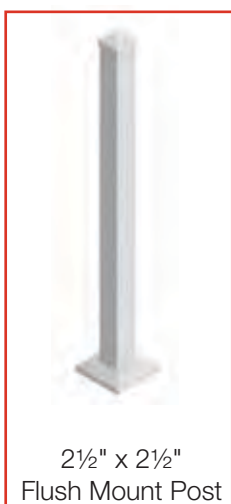

Level Rail Panels

Description	White	Matte Black	Matte Bronze
6' x 36" Level Rail Panel with Square Balusters	73019269	73019285	73019458
8' x 36" Level Rail Panel with Square Balusters	73019270	73019286	73019464
6' x 42" Level Rail Panel with Square Balusters	73019273	73019289	73019459
8' x 42" Level Rail Panel with Square Balusters	73019274	73019290	73019465

Stair Rail Panels

Description	White	Matte Black	Matte Bronze
6' x 36" Stair Rail Panel with Square Balusters	73019271	73019287	73019466
8' x 36" Stair Rail Panel with Square Balusters	73019272	73019288	73019468
6' x 42" Stair Rail Panel with Square Balusters	73019275	73019291	73019467
8' x 42" Stair Rail Panel with Square Balusters	73019276	73019292	73019469

Rail panels include bracket kit (two top and two bottom brackets) and support foot with mounting hardware. Top rail sold separately – see page 16.

2-to-3 Rail Adapter

Description	White	Matte Black	Matte Bronze
6' Rail Adapter	73050440	73050438	73050442
8' Rail Adapter	73050441	73050439	73050443

Adapter includes bracket kit (two top and two bottom brackets) with bracket covers and mounting hardware.

Glass Level Rail Kits

Description	White	Matte Black	Matte Bronze
6' Beam Kit for Glass Slats (level only)	73020648	73020652	73019454
8' Beam Kit for Glass Slats (level only)	73020649	73020653	73019460

6' kits require 9 glass slats and 8' kits require 12 glass slats (sold separately). Top beam, bottom rail, bracket kit (4 level brackets and mounting hardware), support foot and top and bottom gaskets for glass slats included with rail kits.

Glass Slats

Description	For 36" Rail Height	For 42" Rail Height
Glass Slats for Level Kits – Box of 9 – For Use with 6' Kits	73041331	73041332
Glass Slats for Level Kits – Box of 12 – For Use with 8' Kits	73041333	73041334



Beam Kits for 3' x 6' Decorative Screen Panel Infill			
Description	White	Matte Black	Matte Bronze
6' x 36" Beam Kit for Decorative Screen Panels (sold separately)	73044011	73044009	73044010

Beam kits include top beam, bottom rail, bracket kit (4 level brackets and mounting hardware) and support foot.

3' x 6' Decorative Screen Panels				
Description	Boardwalk	Sanibel	River Rock	Optic
3' x 6' x 0.3" – White	73045664	N/A	N/A	N/A
3' x 6' x 0.3" – Gray	73045665	N/A	N/A	N/A
3' x 6' x 0.3" – Black	73030561	73050460	73045667	73050083

Actual size: 34" x 68" x 0.3".



Boardwalk



Sanibel
Design Patent Pending

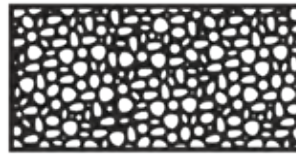

River Rock

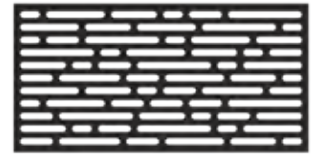

Optic

Decorative Screen Panels are designed with a matte, textured finish to allow them to be painted for complete customization.

Top Rails			
Description	White	Matte Black	Matte Bronze
6' Top Rail – Pellinore	73020442	73020448	73019456
8' Top Rail – Pellinore	73020443	73020449	73019462
6' Top Rail – Tristan	73020446	73020452	73019457
8' Top Rail – Tristan	73020447	73020453	73019463
6' Top Rail – Oberon*	73032049	73032042	73032048
8' Top Rail – Oberon*	73032052	73032050	73032051

Top Rails include 2 matching end covers.

*Oberon top rail is intended for level applications only. Deck board must be installed on top of Oberon profile.



Pellinore™



Tristan™

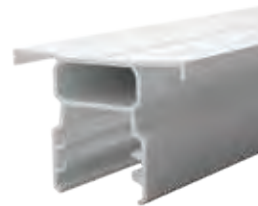

Oberon™*

Brackets

Description	White	Matte Black	Matte Bronze
Pellinore Level Bracket Kit (set of 4 – 2 top, 2 bottom)	73019301	73019298	73019490
Pellinore Stair Bracket Kit (set of 4 – 2 top, 2 bottom)	73019310	73019307	73019491
Pellinore Fixed Angle Stair Bracket (set of 4 – 2 top, 2 bottom)	73045480	73045479	73045481
Pellinore Angle Bracket Kit (set of 4 – 2 top, 2 bottom)	73019318	73019319	73019489
Tristan Level Bracket Kit (set of 4 – 2 top, 2 bottom)	73019300	73019297	73019496
Tristan Stair Bracket Kit (set of 4 – 2 top, 2 bottom)	73019309	73019306	73019497
Tristan Fixed Angle Stair Bracket (set of 4 – 2 top, 2 bottom)	73045483	73045482	73045484
Tristan Angle Bracket Kit (set of 4 – 2 top, 2 bottom)	73019315	73019316	73019495
Oberon Level Bracket Kit (set of 4 – 2 top, 2 bottom)	73040784	73040785	73040786



Brackets shown with Pellinore top rail and top rail end cover. Fixed angle stair brackets not available for Oberon.
 Typical new stair construction utilizes a 7" rise and an 11" run which results in a 32° stair angle.

Accessories

Description	
BracketPro™ Installation Jig – for use with 2", 2½" and 4¼" posts	73053555

Easily locates holes on posts to install brackets and provides level railing without having to measure or center brackets manually. For use with 2", 2½" and 4¼" posts.
 With 2" Over-the-Top posts, BracketPro can be used to locate the bottom brackets only.



BracketPro



2-to-3 Rail Brackets

Description	White	Matte Black	Matte Bronze
2-to-3 Rail Bracket Kit (set of 4 – 2 top, 2 bottom)	73050446	73050444	73050445
2-to-3 Rail Angle Bracket Kit (set of 4 – 2 top, 2 bottom)	73050449	73050447	73050448



2-to-3 Rail Bracket Kit



2-to-3 Rail Angle Bracket Kit

Over-the-Top Brackets

Description	White	Matte Black	Matte Bronze
Pellinore 2" Over-the-Top Post Bracket – Mid Post	73020663	73020681	73019487
Pellinore 2" Over-the-Top Post Bracket – Corner Post	73020664	73020682	73019486
Pellinore 2" Over-the-Top Post Bracket – End Post	73020665	73020683	73019488
Tristan 2" Over-the-Top Post Bracket – Mid Post	73020666	73020684	73019494
Tristan 2" Over-the-Top Post Bracket – Corner Post	73020667	73020685	73019492
Tristan 2" Over-the-Top Post Bracket – End Post	73020668	73020686	73019493
Oberon 2" Over-the-Top Post Bracket – Mid Post*	73040798	73040797	73040799
Oberon 2" Over-the-Top Post Bracket – Corner Post*	73040801	73040800	73040802
Oberon 2" Over-the-Top Post Bracket – End Post	73040788	73040787	73040796

*Does not include bracket covers; deck board will install over the top of Oberon top rail.



Mid Bracket



Corner Bracket

Style shown for use with Pellinore Top Rail



End Bracket

Fascia Bracket Kits

Description	White	Matte Black	Matte Bronze
Fascia Mount Mid Bracket Kit	73045489	73045488	73045490
Fascia Mount Outside Corner Bracket Kit	73045492	73045491	73045493
Fascia Mount Insider Corner Bracket Kit	73045495	73045494	73045496
Fascia Mount Juliette Bracket Kit	73045498	73045497	73045499
Fascia Mount Juliette Spacer*	73050297		

*Only necessary when Juliette application is using a fascia mid bracket and post.



Mid Bracket Kit



Outside Corner Bracket Kit



Inside Corner Bracket Kit



Juliette Bracket Kit



Fascia Mount Juliette Spacer

929 LIGHTING™

60081

ATLESS ONE LIGHT OUTDOOR WALL LANTERN

Dimensions

Width	6"
Height	17"
Depth	7.5"
Backplate Width	4.57"
Backplate Height	7.41"
Backplate Depth	0.91"
Weight	7.75 lbs.

Finish & Material

Finishes	PBK - Powder Coated Black PBZ - Powder Coated Bronze
----------	---------------------------------------------------------------------------

Material	Steel
----------	-------

Glass/Shade

Glass	Clear
-------	-------

Wattage

# Bulbs	1-Medium
Bulbs Base	Medium (E26)
Watts per Bulb	60W
Voltage	120V
Total Wattage	60W
Bulbs Included	No

Certification

UL Listed	Wet Location
-----------	--------------

Item Number

SKU'S	60081 PBK 60081 PBZ
-------	-----------------------------------



60081 PBK



60081 PBZ



Superior Value in High Quality Lighting



Composite in a class of its own,
with unmatched wood looks

- DURABLE** Won't split, splinter, or rot
 - LOW MAINTENANCE** No sanding, staining, or sealing — ever
 - FADE RESISTANT** Maintains its rich color for decades*
 - MOISTURE RESISTANT** Protected from mold, mildew, and rot
 - WARRANTY PROTECTION** 30- and 25-Year Limited Warranties that vary by collection**
 - SUSTAINABLE** Made in the USA from approximately 85% recycled material
- BETTER SIDED CAPPING MAKES THE DIFFERENCE**
Four-sided capping for superior moisture resistance
Three-sided capping for excellent moisture resistance
- COLLECTIONS**
Legacy, Reserve, Terrain+™, Terrain®
Prime+, Prime, Premier



Reserve Collection in Reclaimed Chestnut

*Depending on environmental conditions, TimberTech Composite Deck colors may appear to change over time as part of the natural weathering process consistent with the warranty guarantees where applicable. **TimberTech Prime+, Prime, and Premier Collections are covered by a 25-Year Limited Product Warranty and a 25-Year Fade & Stain Limited Warranty. The proprietary capping on the Prime+, Prime, and Premier Collections does not feature Mold Guard Technology.

LEGACY COLLECTION

Hand-Scraped Finish

Choose the Legacy Collection for an artisanal, craftsman-inspired look. With cascading hues, a textured, hand-scraped finish, and a variable grain pattern, each board is unique — perfect for clients wanting a one-of-a-kind deck.

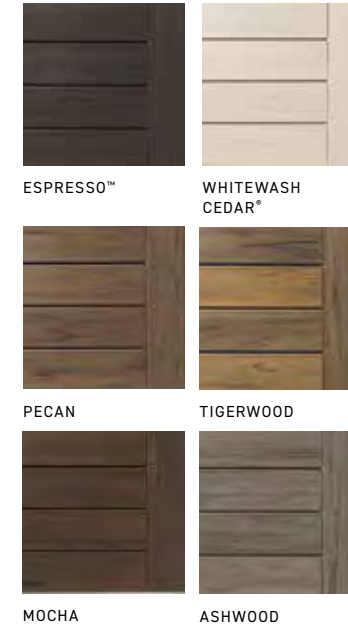

MOCHA ASHWOOD

PRODUCT DESCRIPTION	TimberTech Model Number		
	12'	16'	20'
LEGACY COLLECTION			
1 x 6 Grooved Espresso	LCGV5412E	LCGV5416E	LCGV5420E
1 x 6 Square-Shouldered Espresso	—	LC5416E	LC5420E
1 x 6 Grooved Whitewash Cedar	LCGV5412WC	LCGV5416WC	LCGV5420WC
1 x 6 Square-Shouldered Whitewash Cedar	—	LC5416WC	LC5420WC
1 x 6 Grooved Mocha	LCGV5412M	LCGV5416M	LCGV5420M
1 x 6 Square-Shouldered Mocha	—	LC5416M	LC5420M
1 x 6 Grooved Pecan	LCGV5412P	LCGV5416P	LCGV5420P
1 x 6 Square-Shouldered Pecan	—	LC5416P	LC5420P
1 x 6 Grooved Tigerwood	LCGV5412TW	LCGV5416TW	LCGV5420TW
1 x 6 Square-Shouldered Tigerwood	—	LC5416TW	LC5420TW
1 x 6 Grooved Ashwood	LCGV5412AW	LCGV5416AW	LCGV5420AW
1 x 6 Square-Shouldered Ashwood	—	LC5416AW	LC5420AW
LEGACY FASCIA			
12" Fascia Espresso	FBLC12E	—	—
12" Fascia Whitewash Cedar	FBLC12WC	—	—
12" Fascia Mocha	FBLC12M	—	—
12" Fascia Pecan	FBLC12P	—	—
12" Fascia Tigerwood	FBLC12TW	—	—
12" Fascia Ashwood	FBLC12AW	—	—
LEGACY RISER			
7-1/4" Riser Espresso	LCRISERE	—	—
7-1/4" Riser Whitewash Cedar	LCRISERWC	—	—
7-1/4" Riser Mocha	LCRISERM	—	—
7-1/4" Riser Pecan	LCRISERP	—	—
7-1/4" Riser Tigerwood	LCRISERTW	—	—
7-1/4" Riser Ashwood	LCRISERAW	—	—

PROFILE OPTIONS

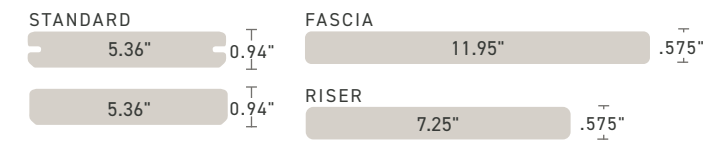

Legacy Collection in Tigerwood



Reserve Collection in Antique Leather®
Classic Composite Series in Black with Drink Rail



Terrain+ Collection in Weathered Oak
Impression Rail Express® in Black with Modern Top Rail

RESERVE COLLECTION

Reclaimed Wood

For clients looking to capture the character-rich look and feel of reclaimed wood, go with the Reserve Collection. These boards feature bold, cascading colors, a rustic cathedral grain, and a wire-brushed finish.



DRIFTWOOD DARK ROAST® ANTIQUE LEATHER®



RECLAIMED CHESTNUT™

PROFILE OPTIONS

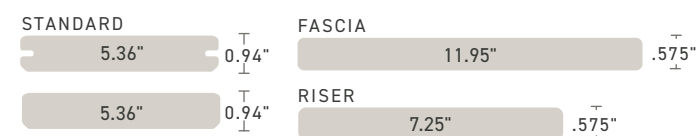

PRODUCT DESCRIPTION	TimberTech Model Number		
	12'	16'	20'
RESERVE COLLECTION			
1 x 6 Grooved Driftwood	RCGV5412DW	RCGV5416DW	RCGV5420DW
1 x 6 Square-Shouldered Driftwood	—	RC5416DW	RC5420DW
1 x 6 Grooved Antique Leather	RCGV5412AL	RCGV5416AL	RCGV5420AL
1 x 6 Square-Shouldered Antique Leather	—	RC5416AL	RC5420AL
1 x 6 Grooved Dark Roast	RCGV5412DR	RCGV5416DR	RCGV5420DR
1 x 6 Square-Shouldered Dark Roast	—	RC5416DR	RC5420DR
1 x 6 Grooved Reclaimed Chestnut	RCGV5412RC	RCGV5416RC	RCGV5420RC
1 x 6 Square-Shouldered Reclaimed Chestnut	—	RC5416RC	RC5420RC
RESERVE FASCIA			
12" Fascia Driftwood	FBRC12DW	—	—
12" Fascia Antique Leather	FBRC12AL	—	—
12" Fascia Dark Roast	FBRC12DR	—	—
12" Fascia Reclaimed Chestnut	FBRC12RC	—	—
RESERVE RISER			
7-1/4" Riser Driftwood	RCRISERDW	—	—
7-1/4" Riser Antique Leather	RCRISERAL	—	—
7-1/4" Riser Dark Roast	RCRISERDR	—	—
7-1/4" Riser Reclaimed Chestnut	RCRISERRC	—	—

WUI-COMPLIANT FIRE-RESISTANT SKUS

FOR FIRE ZONES

The fire-resistant (FR) SKUs of the Reserve Collection are WUI Compliant, making them a smart choice for fire zones.

TERRAIN+ COLLECTION™

Subtle Wood Grain

For clients who want maximum style for their dollar, we offer the new Terrain+ Collection. It features the same lightweight, scalloped profile, but with an updated color palette. Thanks to new and improved color blending technology, these boards deliver sophisticated colors with a subtle grain pattern like sanded white oak and walnut for a versatile, natural wood look. It's also our first scalloped board that's compatible with Cortex plugs.

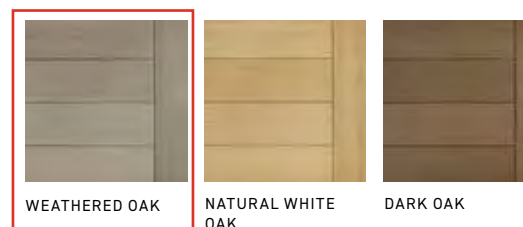

WEATHERED OAK NATURAL WHITE OAK DARK OAK

PRODUCT DESCRIPTION	TimberTech Model Number		
	12'	16'	20'
TERRAIN+ COLLECTION			
1 x 6 Grooved Natural White Oak	TCGV5412NW	TCGV5416NW	TCGV5420NW
1 x 6 Square-Shouldered Natural White Oak	—	TC5416NW	TC5420NW
1 x 6 Grooved Weathered Oak	TCGV5412WO	TCGV5416WO	TCGV5420WO
1 x 6 Square-Shouldered Weathered Oak	—	TC5416WO	TC5420WO
1 x 6 Grooved Dark Oak	TCGV5412DO	TCGV5416DO	TCGV5420DO
1 x 6 Square-Shouldered Dark Oak	—	TC5416DO	TC5420DO
TERRAIN+ FASCIA			
12" Fascia Natural White Oak	FBTC12NW	—	—
12" Fascia Weathered Oak	FBTC12WO	—	—
12" Fascia Dark Oak	FBTC12DO	—	—
TERRAIN+ RISER			
7-1/4" Riser Natural White Oak	TCRISERNW	—	—
7-1/4" Riser Weathered Oak	TCRISERWO	—	—
7-1/4" Riser Dark Oak	TCRISERDO	—	—

PROFILE OPTIONS

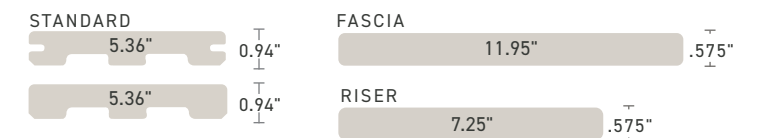

Project		Catalog #		Type	
Prepared by		Notes		Date	



Streetworks

UTLD Traditional

Decorative Post Top Luminaire

Typical Applications

Outdoor • Parking Lots • Walkways • Roadways • Building Areas

Interactive Menu

- Ordering Information [page 2](#)
- Product Specifications [page 2](#)
- Energy and Performance Data [page 3](#)

Product Certifications



Product Features



Quick Facts

- Replaces up to 250W equivalent HID
- Asymmetric & Symmetric distributions
- 0-10V dimming driver standard
- UL 1449/MOV surge protection available
- 3G vibration rated

Dimensional Details

UTLD

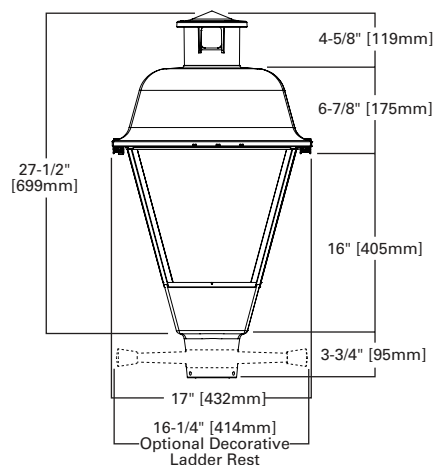

UTLD - Tall Cupola

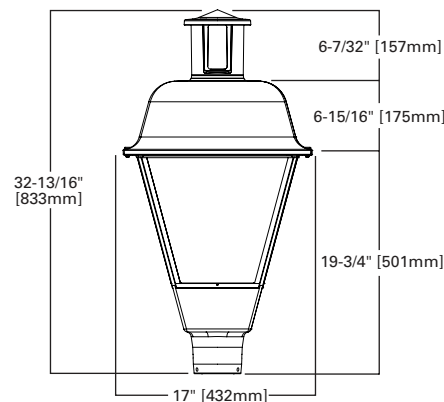

Optional Bird Cone

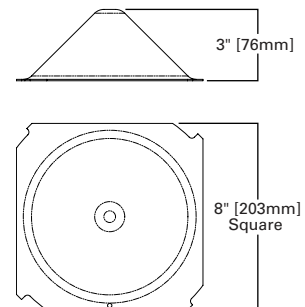

Ordering Information

SAMPLE NUMBER: **UTLD-PA1-100-740-U-T2U-CL-BK**

Product Family ¹	Configuration	Wattage Bucket	Color Temperature	Voltage	Distribution	Lens	Finish
UTLD =Traditionaire™ LED Downtlight	PA1 =Direct Mount Rectangle (24 LED)	20=20W ² 30=30W 40=40W 50=50W 60=60W 70=70W 80=80W 90=90W 100 =100W	740 =70CRI, 4000K 727 =70CRI, 2700K ⁶ 827 =80CRI, 2700K ⁶ 730 =70CRI, 3000K ⁶ 750 =70CRI, 5000K ⁶ AMB =Amber 590nm	U =Universal (120-277V) 2 =120V ² 8 =480V ^{4,5} 9 =347V ⁵	T2U =Type II Urban T3 =Type III T4W =Type IV Wide 5WQ =Type V Square Wide SL3 =Type III w/ Spill Control	[Blank] =Open (No Lens) A =Refractive Lens Panels ⁹ CL =Clear Lens Panel ⁹ FP =Frosted Lens Panel ⁹ TL =Textured Lens Panel ⁹	BK =Black AP =Grey BZ =Bronze WH =White
Options (Add as Suffix)			Controls		Accessories (Order Separately)		
10K =Series 10kV UL 1449 Surge Protective Device 20K =Series 20kV UL 1449 Surge Protective Device 20KI =Series 20kV UL 1449 Surge Protective Device with light indicator 20MSP =Parallel 20kV MOV Surge Protective Device 10MSP =10kV MOV Surge Protection Device HA =50°C High Ambient Temperature ⁸ W =20" #10 Input Leads S =Snap Latches for Tool-less Light Replacement J =Factory Installed Ladder Rest BC =Bird Cone ⁹ HSS =Factory Install UTLD House Side Shield ¹⁰ TC =Tall Cupola ¹¹ PSC =Photocontrol Shorting Cap NPC =NEMA Photocontrol - Multi-Tap LLPC =Longlife Photocontrol Included CC =Coastal construction finish ¹² FADC =Field Adjustable Dimming Controller			5LTD =DALI ³ PR =NEMA Photocontrol Receptacle ⁷ PR7 =NEMA 7-PIN Twistlock Photocontrol Receptacle		TA1BK =Decorative Ladder Rest for Field Installation (Black) QA/RA1013 =Photocontrol Shorting Cap QA/RA1014 =NEMA Photocontrol - 120V QA/RA1016 =NEMA Photocontrol - Multi-Tap QA/RA1027 =NEMA Photocontrol - 480V QA/RA1201 =NEMA Photocontrol - 347V QA1223 =10kV Surge Module Replacement HS-UTLD-24 =Field Installed UTLD House Side Shield for PA1 ¹⁰ VGS-ARCH =Short Vertical Drop Shield VGL-ARCH =Long Vertical Drop Shield		
NOTES: 1. Customer is responsible for engineering analysis to confirm pole and fixture compatibility for all applications. Refer to our white paper WP513001EN for additional support information. 2. PA1-20 only available in 120V. 3. Only available in universal voltage. Consult your lighting representative at Cooper Lighting Solutions if custom programming is required. Not available with PA1-90, PA1-100. Consult your lighting representative at Cooper Lighting Solutions if greater than PA1-80 (83W) is needed. 4. Only for use with 480V Wye systems. Per NEC, not for use with ungrounded systems, impedance grounded systems or corner grounded systems (commonly known as Three Phase Three Wire Delta, Three Phase High Leg Delta and Three Phase Corner Grounded Delta systems). 5. Not available with 5LTD driver. 6. Use dedicated IES files for when performing layouts. These files are published on the UTLD Traditionaire product page on the website. 7. If "PR" selected, dimming functionality not available, dimming leads will be capped. 8. Not available with HSS or 5LTD driver. 9. Lens panel and birdcone cannot be ordered together. 10. HSS not available with 5WQ distribution. 11. Use tall cupola to accommodate network control solutions requiring the 7-pin receptacle. 12. Coastal construction finish salt spray tested to over 5,000-hours per ASTM B117, with a scribe rating of 9 per ASTM D1654.							

Product Specifications

Construction

- Hinged (stainless steel hinge pins) die-cast aluminum housing and cover with cupola.
- 3G vibration tested to ensure strength of construction and longevity in application.

Optics

- Choice of five patented, high-efficiency AccuLED Optic™ technology manufactured from injection-molded acrylic.
- Optics are precisely designed to shape the light output, maximizing efficiency and application spacing.
- AccuLED Optic technology creates consistent distributions with the scalability to meet customized application requirements.
- Optional 2700K, 3000K, 4000K and 5000K CCT. For the ultimate level of spill light control, an optional house-side shield accessory can be field, or factory installed.
- Optics are IP66 enclosure rated.
- Offered open sided as a standard with four lens options.

Electrical

- LED drivers mount to die-cast aluminum back housing for optimal heat sinking, operation efficacy, and prolonged life.
- Standard drivers feature electronic universal voltage (120-277V 50/60Hz), 347V 60Hz or 480V 60Hz operation, greater than 0.9 power factor, less than 20% harmonic distortion, and is suitable for operation in -40°C to 40°C ambient environments.
- Surge protection options: 10kV/10kA common - and differential - mode surge protection. Optional 20kV (light indicator optional), 10kV MOV, and 20kV MOV surge protection devices.

Mounting

- Self-aligning pole-top fitter for 3" O.D. pole tops or vertical tenons.
- Square headed 1-1/4" polymer coated mounting bolts with a lock nut.

Finish

- Cast components finished in a super TGIC polyester powder coat paint, 2.5 mil nominal thickness for superior protection against fade and wear.
- Optional colors include bronze, grey and white. RAL and custom color matches available.

Shipping Data

- Approximate Net Weight: 37 lbs. (17 kgs.)
- Effective Projected Area: 2.3 (Sq. Ft.)

Warranty

- Standard five-year warranty.
- Optional ten-year warranty, please see your Cooper Lighting Solutions Streetworks sales representative for more information.

Energy and Performance Data

Power and Lumens (Standard Configuration - No Bird Cone)

Light Engine *	PA1-20	PA1-30	PA1-40	PA1-50	PA1-60	PA1-70	PA1-80	PA1-90	PA1-100	
Nominal Power (Watts)	21	31	40	54	64	74	83	94	96	
Wattage Label	20	30	40	50	60	70	80	90	100	
Current @ 120V (A)	0.18	0.26	0.34	0.45	0.53	0.62	0.70	0.78	0.80	
Current @ 277V (A)	--	0.12	0.15	0.21	0.24	0.28	0.31	0.35	0.35	
Current @ 347V (A)	--	0.10	0.13	0.16	0.19	0.22	0.24	0.28	0.28	
Current @ 480V (A)	--	0.07	0.09	0.13	0.14	0.17	0.18	0.21	0.21	
Optics										
T2U	4000K	2,875	4,024	5,231	6,705	7,794	8,723	9,544	10,321	10,343
	Lumens per Watt	137	130	131	124	122	118	115	110	108
	BUG Rating	B1-U0-G1	B1-U0-G1	B2-U0-G2	B2-U0-G2	B2-U0-G2	B2-U0-G2	B3-U0-G3	B3-U0-G3	B3-U0-G3
	3000K	2,618	3,665	4,764	6,107	7,098	7,944	8,692	9,400	9,419
	Lumens per Watt	125	118	119	113	111	107	105	100	98
	BUG Rating	B1-U0-G1	B1-U0-G1	B2-U0-G2	B2-U0-G2	B2-U0-G2	B2-U0-G2	B2-U0-G2	B3-U0-G3	B3-U0-G3
T2U-A	4000K	2,461	3,444	4,476	5,740	6,672	7,466	8,168	8,834	8,853
	Lumens per Watt	117	111	112	106	104	101	98	94	92
	BUG Rating	B1-U3-G1	B1-U3-G1	B1-U3-G2	B2-U3-G2	B2-U4-G2	B2-U4-G2	B2-U4-G2	B2-U4-G2	B2-U4-G2
	3000K	2,241	3,136	4,077	5,227	6,076	6,798	7,438	8,045	8,063
	Lumens per Watt	107	101	102	97	95	92	90	86	84
	BUG Rating	B1-U3-G1	B1-U3-G1	B1-U3-G2	B1-U3-G2	B2-U3-G2	B2-U4-G2	B2-U4-G2	B2-U4-G2	B2-U4-G2
T2U-CL	4000K	2,682	3,754	4,880	6,258	7,273	8,138	8,905	9,631	9,651
	Lumens per Watt	128	121	122	116	114	110	107	102	101
	BUG Rating	B1-U2-G1	B1-U3-G1	B2-U3-G2	B2-U3-G2	B2-U3-G2	B3-U3-G3	B3-U3-G3	B3-U3-G3	B3-U3-G3
	3000K	2,443	3,419	4,445	5,698	6,624	7,412	8,110	8,770	8,790
	Lumens per Watt	116	110	111	106	104	100	98	93	92
	BUG Rating	B1-U2-G1	B1-U2-G1	B2-U3-G2	B2-U3-G2	B2-U3-G2	B2-U3-G2	B3-U3-G3	B3-U3-G3	B3-U3-G3
T2U-TL	4000K	2,637	3,690	4,799	6,152	7,151	8,002	8,755	9,468	9,488
	Lumens per Watt	126	119	120	114	112	108	105	101	99
	BUG Rating	B1-U3-G1	B1-U3-G1	B2-U3-G2	B2-U3-G2	B2-U3-G2	B3-U3-G3	B3-U3-G3	B3-U3-G3	B3-U3-G3
	3000K	2,402	3,362	4,369	5,602	6,512	7,287	7,973	8,622	8,640
	Lumens per Watt	114	108	109	104	102	98	96	92	90
	BUG Rating	B1-U2-G1	B1-U3-G1	B2-U3-G2	B2-U3-G2	B2-U3-G2	B2-U3-G2	B3-U3-G3	B3-U3-G3	B3-U3-G3
T2U-FP	4000K	2,458	3,441	4,473	5,736	6,668	7,460	8,164	8,828	8,847
	Lumens per Watt	117	111	112	106	104	101	98	94	92
	BUG Rating	B1-U3-G2	B1-U3-G2	B1-U3-G3	B2-U4-G3	B2-U4-G3	B2-U4-G3	B2-U4-G4	B2-U4-G4	B2-U4-G4
	3000K	2,240	3,134	4,075	5,224	6,072	6,795	7,434	8,039	8,056
	Lumens per Watt	107	101	102	97	95	92	90	86	84
	BUG Rating	B1-U3-G2	B1-U3-G2	B1-U3-G3	B2-U4-G3	B2-U4-G3	B2-U4-G3	B2-U4-G3	B2-U4-G3	B2-U4-G3
T2U-HSS	4000K	1,949	2,728	3,547	4,546	5,285	5,914	6,471	6,998	7,013
	Lumens per Watt	93	88	89	84	83	80	78	74	73
	BUG Rating	B0-U0-G1	B0-U0-G1	B0-U0-G1	B0-U0-G1	B0-U0-G1	B0-U0-G1	B0-U0-G1	B0-U0-G1	B1-U0-G2
	3000K	1,775	2,485	3,230	4,141	4,813	5,386	5,893	6,374	6,387
	Lumens per Watt	85	80	81	77	75	73	71	68	67
	BUG Rating	B0-U0-G0	B1-U0-G1	B1-U0-G1	B1-U0-G1	B1-U0-G1	B1-U0-G1	B1-U0-G1	B1-U0-G1	B1-U0-G1

NOTE: * Photometric data is reported for lower hemisphere only.

Power and Lumens (Standard Configuration - No Lenses or Bird Cone)

Light Engine *	PA1-20	PA1-30	PA1-40	PA1-50	PA1-60	PA1-70	PA1-80	PA1-90	PA1-100	
Nominal Power (Watts)	21	31	40	54	64	74	83	94	96	
Wattage Label	20	30	40	50	60	70	80	90	100	
Current @ 120V (A)	0.18	0.26	0.34	0.45	0.53	0.62	0.70	0.78	0.80	
Current @ 277V (A)	--	0.12	0.15	0.21	0.24	0.28	0.31	0.35	0.35	
Current @ 347V (A)	--	0.10	0.13	0.16	0.19	0.22	0.24	0.28	0.28	
Current @ 480V (A)	--	0.07	0.09	0.13	0.14	0.17	0.18	0.21	0.21	
Optics										
SL3	4000K	2,784	3,896	5,065	6,493	7,547	8,446	9,241	9,994	10,015
	Lumens per Watt	133	126	127	120	118	114	111	106	104
	BUG Rating	B1-U0-G1	B1-U0-G2	B1-U0-G2	B1-U0-G3	B1-U0-G3	B1-U0-G3	B2-U0-G3	B2-U0-G3	B2-U0-G3
	3000K	2,535	3,548	4,612	5,913	6,873	7,692	8,416	9,102	9,120
	Lumens per Watt	121	114	115	110	107	104	101	97	95
SL3-A	4000K	2,320	3,247	4,219	5,410	6,288	7,037	7,699	8,326	8,344
	Lumens per Watt	110	105	105	100	98	95	93	89	87
	BUG Rating	B1-U3-G1	B1-U3-G2	B1-U3-G2	B1-U3-G2	B1-U3-G3	B1-U4-G3	B1-U4-G3	B1-U4-G3	B1-U4-G3
	3000K	2,112	2,956	3,842	4,926	5,726	6,408	7,011	7,583	7,599
	Lumens per Watt	101	95	96	91	89	87	84	81	79
SL3-CL	4000K	2,608	3,651	4,746	6,085	7,073	7,915	8,660	9,365	9,385
	Lumens per Watt	124	118	119	113	111	107	104	100	98
	BUG Rating	B1-U2-G2	B1-U3-G2	B1-U3-G2	B1-U3-G3	B1-U3-G3	B2-U3-G3	B2-U3-G3	B2-U3-G3	B2-U3-G3
	3000K	2,375	3,325	4,322	5,542	6,441	7,208	7,886	8,529	8,546
	Lumens per Watt	113	107	108	103	101	97	95	91	89
SL3-TL	4000K	2,527	3,535	4,597	5,893	6,849	7,665	8,387	9,070	9,090
	Lumens per Watt	120	114	115	109	107	104	101	96	95
	BUG Rating	B1-U3-G2	B1-U3-G2	B1-U3-G2	B1-U3-G3	B2-U3-G3	B2-U3-G3	B2-U3-G3	B2-U3-G3	B2-U3-G3
	3000K	2,300	3,220	4,186	5,366	6,239	6,981	7,639	8,261	8,278
	Lumens per Watt	110	104	105	99	97	94	92	88	86
SL3-FP	4000K	2,344	3,282	4,265	5,470	6,359	7,114	7,784	8,419	8,437
	Lumens per Watt	112	106	107	101	99	96	94	90	88
	BUG Rating	B1-U3-G2	B1-U3-G3	B1-U3-G3	B1-U4-G3	B1-U4-G4	B2-U4-G4	B2-U4-G4	B2-U4-G4	B2-U4-G4
	3000K	2,136	2,989	3,885	4,980	5,790	6,479	7,089	7,667	7,683
	Lumens per Watt	102	96	97	92	90	88	85	82	80
SL3-HSS	4000K	2,305	3,226	4,194	5,376	6,250	6,994	7,652	8,276	8,293
	Lumens per Watt	110	104	105	100	98	95	92	88	86
	BUG Rating	B0-U0-G1	B0-U0-G1	B1-U0-G2	B1-U0-G2	B1-U0-G2	B1-U0-G2	B1-U0-G2	B1-U0-G2	B1-U0-G2
	3000K	2,099	2,938	3,820	4,896	5,692	6,369	6,969	7,537	7,552
	Lumens per Watt	100	95	96	91	89	86	84	80	79
	BUG Rating	B0-U0-G1	B0-U0-G1	B0-U0-G1	B1-U0-G2	B1-U0-G2	B1-U0-G2	B1-U0-G2	B1-U0-G2	B1-U0-G2

NOTE: * Photometric data is reported for lower hemisphere only.

Power and Lumens (Standard Configuration - No Lenses or Bird Cone)

Light Engine *	PA1-20	PA1-30	PA1-40	PA1-50	PA1-60	PA1-70	PA1-80	PA1-90	PA1-100	
Nominal Power (Watts)	21	31	40	54	64	74	83	94	96	
Wattage Label	20	30	40	50	60	70	80	90	100	
Current @ 120V (A)	0.18	0.26	0.34	0.45	0.53	0.62	0.70	0.78	0.80	
Current @ 277V (A)	--	0.12	0.15	0.21	0.24	0.28	0.31	0.35	0.35	
Current @ 347V (A)	--	0.10	0.13	0.16	0.19	0.22	0.24	0.28	0.28	
Current @ 480V (A)	--	0.07	0.09	0.13	0.14	0.17	0.18	0.21	0.21	
Optics										
T3	4000K	2,853	3,992	5,190	6,653	7,733	8,654	9,469	10,241	10,262
	Lumens per Watt	136	129	130	123	121	117	114	109	107
	BUG Rating	B1-U0-G1	B1-U0-G2	B1-U0-G2	B1-U0-G2	B2-U0-G2	B2-U0-G3	B2-U0-G3	B2-U0-G3	B2-U0-G3
	3000K	2,598	3,636	4,726	6,059	7,043	7,882	8,624	9,326	9,345
	Lumens per Watt	124	117	118	112	110	107	104	99	97
T3-A	4000K	2,425	3,395	4,413	5,657	6,577	7,359	8,052	8,709	8,727
	Lumens per Watt	115	110	110	105	103	99	97	93	91
	BUG Rating	B1-U3-G1	B1-U3-G2	B1-U3-G2	B1-U3-G2	B1-U4-G3	B2-U4-G3	B2-U4-G3	B2-U4-G3	B2-U4-G3
	3000K	2,209	3,091	4,019	5,152	5,989	6,702	7,332	7,931	7,947
	Lumens per Watt	105	100	100	95	94	91	88	84	83
T3-CL	4000K	2,695	3,773	4,905	6,288	7,309	8,179	8,949	9,679	9,698
	Lumens per Watt	128	122	123	116	114	111	108	103	101
	BUG Rating	B1-U2-G2	B1-U3-G2	B1-U3-G2	B2-U3-G3	B2-U3-G3	B2-U3-G3	B2-U3-G3	B2-U3-G3	B2-U3-G3
	3000K	2,455	3,435	4,467	5,726	6,656	7,448	8,150	8,815	8,832
	Lumens per Watt	117	111	112	106	104	101	98	94	92
T3-TL	4000K	2,616	3,661	4,760	6,102	7,093	7,937	8,685	9,392	9,413
	Lumens per Watt	125	118	119	113	111	107	105	100	98
	BUG Rating	B1-U3-G2	B1-U3-G2	B1-U3-G2	B2-U3-G3	B2-U3-G3	B2-U3-G3	B2-U3-G3	B2-U3-G3	B2-U3-G3
	3000K	2,382	3,334	4,335	5,558	6,459	7,229	7,909	8,554	8,572
	Lumens per Watt	113	108	108	103	101	98	95	91	89
T3-FP	4000K	2,430	3,401	4,420	5,668	6,588	7,372	8,066	8,723	8,742
	Lumens per Watt	116	110	111	105	103	100	97	93	91
	BUG Rating	B1-U3-G2	B1-U3-G3	B1-U3-G3	B1-U4-G3	B2-U4-G3	B2-U4-G4	B2-U4-G4	B2-U4-G4	B2-U4-G4
	3000K	2,213	3,097	4,026	5,161	5,999	6,714	7,345	7,945	7,961
	Lumens per Watt	105	100	101	96	94	91	88	85	83
T3-HSS	4000K	2,126	2,976	3,869	4,959	5,765	6,451	7,059	7,634	7,650
	Lumens per Watt	101	96	97	92	90	87	85	81	80
	BUG Rating	B0-U0-G1	B0-U0-G1	B0-U0-G1	B1-U0-G2	B1-U0-G2	B1-U0-G2	B1-U0-G2	B1-U0-G2	B1-U0-G2
	3000K	1,973	2,710	3,523	4,517	5,250	5,875	6,428	6,952	6,967
	Lumens per Watt	94	87	88	84	82	79	77	74	73
	BUG Rating	B0-U0-G1	B0-U0-G1	B0-U0-G1	B1-U0-G2	B1-U0-G2	B1-U0-G2	B1-U0-G2	B1-U0-G2	B1-U0-G2

NOTE: * Photometric data is reported for lower hemisphere only.

Power and Lumens (Standard Configuration - No Lenses or Bird Cone)

Light Engine *	PA1-20	PA1-30	PA1-40	PA1-50	PA1-60	PA1-70	PA1-80	PA1-90	PA1-100	
Nominal Power (Watts)	21	31	40	54	64	74	83	94	96	
Wattage Label	20	30	40	50	60	70	80	90	100	
Current @ 120V (A)	0.18	0.26	0.34	0.45	0.53	0.62	0.70	0.78	0.80	
Current @ 277V (A)	--	0.12	0.15	0.21	0.24	0.28	0.31	0.35	0.35	
Current @ 347V (A)	--	0.10	0.13	0.16	0.19	0.22	0.24	0.28	0.28	
Current @ 480V (A)	--	0.07	0.09	0.13	0.14	0.17	0.18	0.21	0.21	
Optics										
T4W	4000K	2,856	3,997	5,196	6,660	7,742	8,664	9,480	10,253	10,274
	Lumens per Watt	136	129	130	123	121	117	114	109	107
	BUG Rating	B1-U0-G1	B1-U0-G2	B1-U0-G2	B1-U0-G2	B2-U0-G3	B2-U0-G3	B2-U0-G3	B2-U0-G3	B2-U0-G3
	3000K	2,601	3,640	4,732	6,066	7,051	7,891	8,634	9,337	9,356
	Lumens per Watt	124	117	118	112	110	107	104	99	97
	BUG Rating	B1-U0-G1	B1-U0-G2	B1-U0-G2	B1-U0-G2	B2-U0-G2	B2-U0-G3	B2-U0-G3	B2-U0-G3	B2-U0-G3
T4W-A	4000K	2,388	3,343	4,346	5,572	6,476	7,247	7,929	8,576	8,594
	Lumens per Watt	114	108	109	103	101	98	96	91	90
	BUG Rating	B1-U3-G2	B1-U3-G2	B1-U3-G2	B1-U3-G3	B1-U4-G3	B2-U4-G3	B2-U4-G3	B2-U4-G3	B2-U4-G3
	3000K	2,175	3,044	3,958	5,073	5,899	6,600	7,221	7,809	7,827
	Lumens per Watt	104	98	99	94	92	89	87	83	82
	BUG Rating	B1-U3-G1	B1-U3-G2	B1-U3-G2	B1-U3-G2	B1-U3-G3	B1-U4-G3	B1-U4-G3	B1-U4-G3	B1-U4-G3
T4W-CL	4000K	2,684	3,758	4,885	6,262	7,280	8,145	7,913	9,639	9,660
	Lumens per Watt	128	121	122	116	114	110	95	103	101
	BUG Rating	B1-U3-G2	B1-U3-G2	B1-U3-G2	B2-U3-G3	B2-U3-G3	B2-U3-G3	B2-U3-G3	B2-U3-G3	B2-U3-G3
	3000K	2,445	3,422	4,449	5,703	6,629	7,418	8,118	8,779	8,797
	Lumens per Watt	116	110	111	106	104	100	98	93	92
	BUG Rating	B1-U2-G2	B1-U3-G2	B1-U3-G2	B1-U3-G3	B2-U3-G3	B2-U3-G3	B2-U3-G3	B2-U3-G3	B2-U3-G3
T4W-TL	4000K	2,595	3,631	4,721	6,053	7,036	7,873	8,615	9,316	9,336
	Lumens per Watt	124	117	118	112	110	106	104	99	97
	BUG Rating	B1-U3-G2	B1-U3-G2	B1-U3-G2	B2-U3-G3	B2-U3-G3	B2-U3-G3	B2-U3-G3	B2-U3-G3	B2-U3-G3
	3000K	2,363	3,306	4,300	5,513	6,407	7,170	7,845	8,485	8,502
	Lumens per Watt	113	107	108	102	100	97	95	90	89
	BUG Rating	B1-U3-G2	B1-U3-G2	B1-U3-G2	B1-U3-G3	B2-U3-G3	B2-U3-G3	B2-U3-G3	B2-U3-G3	B2-U3-G3
T4W-FP	4000K	2,414	3,377	4,391	5,629	6,542	7,322	8,012	8,663	8,683
	Lumens per Watt	115	109	110	104	102	99	97	92	90
	BUG Rating	B1-U3-G2	B1-U3-G3	B1-U3-G3	B1-U4-G3	B2-U4-G4	B2-U4-G4	B2-U4-G4	B2-U4-G4	B2-U4-G4
	3000K	2,197	3,076	3,999	5,126	5,958	6,667	7,296	7,890	7,907
	Lumens per Watt	105	99	100	95	93	90	88	84	82
	BUG Rating	B1-U3-G2	B1-U3-G3	B1-U3-G3	B1-U4-G3	B2-U4-G3	B2-U4-G4	B2-U4-G4	B2-U4-G4	B2-U4-G4
T4W-HSS	4000K	2,092	2,928	3,806	4,879	5,671	6,347	6,944	7,510	7,525
	Lumens per Watt	100	94	95	90	89	86	84	80	78
	BUG Rating	B0-U0-G1	B0-U0-G1	B0-U0-G2	B1-U0-G2	B1-U0-G2	B1-U0-G2	B1-U0-G2	B1-U0-G2	B1-U0-G2
	3000K	1,905	2,666	3,466	4,443	5,165	5,780	6,324	6,840	6,854
	Lumens per Watt	91	86	87	82	81	78	76	73	71
	BUG Rating	B0-U0-G1	B0-U0-G1	B0-U0-G1	B1-U0-G2	B1-U0-G2	B1-U0-G2	B1-U0-G2	B1-U0-G2	B1-U0-G2

NOTE: * Photometric data is reported for lower hemisphere only.

Power and Lumens (Standard Configuration - No Lenses or Bird Cone)

Light Engine *		PA1-20	PA1-30	PA1-40	PA1-50	PA1-60	PA1-70	PA1-80	PA1-90	PA1-100
Nominal Power (Watts)		21	31	40	54	64	74	83	94	96
Wattage Label		20	30	40	50	60	70	80	90	100
Current @ 120V (A)		0.18	0.26	0.34	0.45	0.53	0.62	0.70	0.78	0.80
Current @ 277V (A)		--	0.12	0.15	0.21	0.24	0.28	0.31	0.35	0.35
Current @ 347V (A)		--	0.10	0.13	0.16	0.19	0.22	0.24	0.28	0.28
Current @ 480V (A)		--	0.07	0.09	0.13	0.14	0.17	0.18	0.21	0.21
Optics										
5WQ	4000K	2,971	4,158	5,405	6,929	8,055	9,014	9,862	10,666	10,688
	Lumens per Watt	141	134	135	128	126	122	119	113	111
	BUG Rating	B2-U0-G1	B3-U0-G1	B3-U0-G2	B3-U0-G2	B3-U0-G2	B4-U0-G2	B4-U0-G2	B4-U0-G3	B4-U0-G3
	3000K	2,706	3,787	4,923	6,310	7,335	8,209	8,982	9,714	9,734
	Lumens per Watt	129	122	123	117	115	111	108	103	101
	BUG Rating	B2-U0-G1	B3-U0-G1	B3-U0-G2	B3-U0-G2	B3-U0-G2	B3-U0-G2	B4-U0-G2	B4-U0-G2	B4-U0-G2
5WQ-A	4000K	2,480	3,471	4,513	5,786	6,726	7,525	8,235	8,905	8,924
	Lumens per Watt	118	112	113	107	105	102	99	95	93
	BUG Rating	B1-U3-G1	B1-U3-G2	B2-U3-G2	B2-U3-G2	B2-U4-G2	B2-U4-G3	B2-U4-G3	B2-U4-G3	B2-U4-G3
	3000K	2,259	3,161	4,110	5,269	6,125	6,853	7,499	8,110	8,128
	Lumens per Watt	108	102	103	98	96	93	90	86	85
	BUG Rating	B1-U3-G1	B1-U3-G2	B2-U3-G2	B2-U3-G2	B2-U3-G2	B2-U4-G2	B2-U4-G3	B2-U4-G3	B2-U4-G3
5WQ-CL	4000K	2,854	3,995	5,192	6,658	7,739	8,660	9,475	10,248	10,269
	Lumens per Watt	136	129	130	123	121	117	114	109	107
	BUG Rating	B2-U3-G2	B3-U3-G2	B3-U3-G2	B3-U3-G3	B3-U3-G3	B3-U3-G3	B4-U3-G3	B4-U3-G3	B4-U3-G3
	3000K	2,599	3,639	4,730	6,063	7,048	7,886	8,630	9,333	9,352
	Lumens per Watt	124	117	118	112	110	107	104	99	97
	BUG Rating	B2-U3-G1	B3-U3-G2	B3-U3-G2	B3-U3-G2	B3-U3-G3	B3-U3-G3	B3-U3-G3	B3-U3-G3	B3-U3-G3
5WQ-TL	4000K	2,730	3,821	4,967	6,368	7,402	8,283	9,063	9,802	9,823
	Lumens per Watt	130	123	124	118	116	112	109	104	102
	BUG Rating	B2-U3-G2	B3-U3-G2	B3-U3-G2	B3-U3-G3	B3-U3-G3	B3-U3-G3	B3-U3-G3	B4-U3-G3	B4-U3-G3
	3000K	2,486	3,480	4,524	5,799	6,741	7,544	8,254	8,926	8,945
	Lumens per Watt	118	112	113	107	105	102	99	95	93
	BUG Rating	B2-U3-G2	B2-U3-G2	B3-U3-G2	B3-U3-G3	B3-U3-G3	B3-U3-G3	B3-U3-G3	B3-U3-G3	B3-U3-G3
5WQ-FP	4000K	2,545	3,563	4,630	5,938	6,901	7,722	8,450	9,140	9,158
	Lumens per Watt	121	115	116	110	108	104	102	97	95
	BUG Rating	B1-U3-G2	B2-U3-G2	B2-U3-G3	B2-U4-G3	B3-U4-G3	B3-U4-G3	B3-U4-G4	B3-U4-G4	B3-U4-G4
	3000K	2,318	3,245	4,217	5,408	6,285	7,033	7,696	8,322	8,340
	Lumens per Watt	110	105	105	100	98	95	93	89	87
	BUG Rating	B1-U3-G2	B2-U3-G2	B2-U3-G3	B2-U4-G3	B3-U4-G3	B3-U4-G3	B3-U4-G3	B3-U4-G4	B3-U4-G4

NOTE: * Photometric data is reported for lower hemisphere only.

Lumen Maintenance

Light Engine	Ambient Temperature	TM-21 Lumen Maintenance (60,000 Hours)	Theoretical L70 (Hours)
PA1	Up to 40°C	> 98%	> 800,000

Lumen Multiplier

Ambient Temperature	Lumen Multiplier
0°C	1.02
10°C	1.01
25°C	1.00
40°C	0.99
50°C	0.97

FADC Settings

FADC Position	Percent of Typical Lumen Output
1	25%
2	46%
3	55%
4	62%
5	72%
6	77%
7	82%
8	85%
9	90%
10	100%

Note: +/-5% typical value